

# MADISON Two-hole bath mixer for free-standing assembly with hand shower set - Durabron (23kt Gold)

MADISON







25 943 360



- 245mm projection
- spout: rectangular normal flow
- Hand shower: COMPACT RAIN, max. flow rate 6.8 l/min (at 3 bar)
- hand shower with anti-scale system
- rotary diverter for bath/shower
- wall bracket
- total height 901 mm
- stand pipes height 730 mm
- height up to aerator 610 mm
- slide-on rosettes Ø 90 mm
- gauge 153 mm
- metal shower hose 1250mm with integrated anti-twist protection
- max. flow 51 l/min at 3 bar flow pressure
- WRAS 1911027

**Intrinsic protection against back flow.**

Intrinsic protection against back flow.

	Durabron (23kt Gold)	25 943 360-09
	Chrome	25 943 360-00
	Brushed Platinum	25 943 360-06
	Platinum	25 943 360-08
	Brushed Durabron (23kt Gold)	25 943 360-28
	Brushed Dark Platinum	25 943 360-99

## Required miscellaneous



### Concealed floor mounting -

35 944 970 90

- max. recess depth 160 mm
- min. recess depth 80 mm



# MADISON Two-hole bath mixer for free-standing assembly with hand shower set - Durabronz (23kt Gold)

MADISON

25 943 360  
mm [inches]

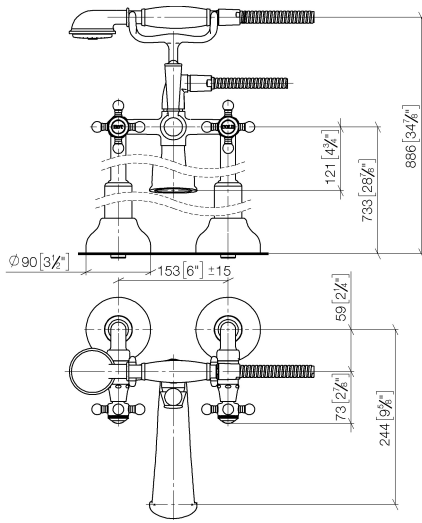

## Flow rate chart



## Codes & Standards

ASME A112.18.1

cUPC

EN 1717

Scottish Water  
Byelaws

UK Water Supply  
Regulations



MADISON Two-hole bath mixer for free-standing assembly with hand shower set - Durabronss (23kt Gold)

---

MADISON

25 943 360

Certificates

---

IAPMO\_4976

WRAS\_1911

Belgaqua\_21-378-2

MADISON Two-hole bath mixer for free-standing assembly with hand shower set - Durabronz (23kt Gold)

MADISON

25 943 360

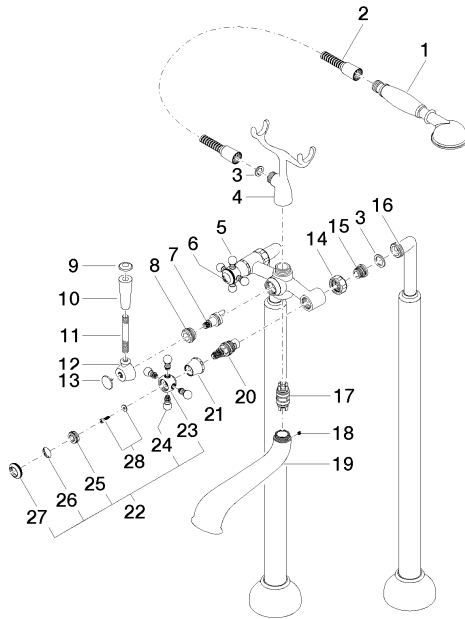



MADISON Two-hole bath mixer for free-standing assembly with hand shower set - Durabronss (23kt Gold)

MADISON

25 943 360

**Spare parts list**

No.	Item Number	Name	Quantity used	Delivery time
	28 002 970-09	MADISON Metal hand shower with porcelain insert (white) - Durabronss (23kt Gold)	43	40