

MADISON Two-hole bath mixer for free-standing assembly with hand shower set - Brushed Dark Platinum

MADISON







25 943 360



- 245mm projection
- spout: rectangular normal flow
- Hand shower: COMPACT RAIN, max. flow rate 6.8 l/min (at 3 bar)
- hand shower with anti-scale system
- rotary diverter for bath/shower
- wall bracket
- total height 901 mm
- stand pipes height 730 mm
- height up to aerator 610 mm
- slide-on rosettes Ø 90 mm
- gauge 153 mm
- metal shower hose 1250mm with integrated anti-twist protection
- max. flow 51 l/min at 3 bar flow pressure
- WRAS 1911027

Intrinsic protection against back flow.

Intrinsic protection against back flow.

	Brushed Dark Platinum	25 943 360-99
	Chrome	25 943 360-00
	Brushed Platinum	25 943 360-06
	Platinum	25 943 360-08
	Durabress (23kt Gold)	25 943 360-09
	Brushed Durabress (23kt Gold)	25 943 360-28

Required miscellaneous



Concealed floor mounting -

35 944 970 90

- max. recess depth 160 mm
- min. recess depth 80 mm



MADISON Two-hole bath mixer for free-standing assembly with hand shower set - Brushed Dark Platinum

MADISON

25 943 360
mm [inches]

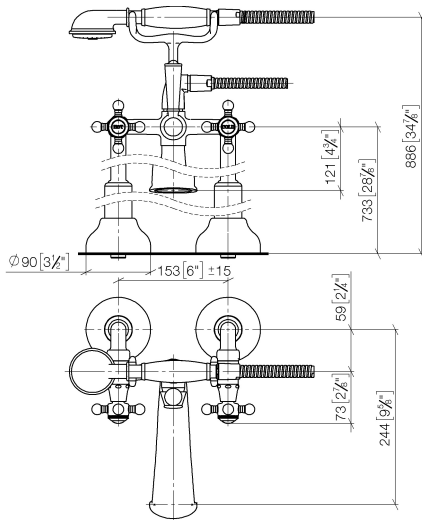

Flow rate chart



Codes & Standards

ASME A112.18.1

cUPC

EN 1717

Scottish Water
Byelaws

UK Water Supply
Regulations



MADISON Two-hole bath mixer for free-standing assembly with hand shower set - Brushed Dark Platinum

MADISON

25 943 360

Certificates

IAPMO_4976

WRAS_1911

Belgaqua_21-378-2

MADISON Two-hole bath mixer for free-standing assembly with hand shower set - Brushed Dark Platinum

MADISON

25 943 360

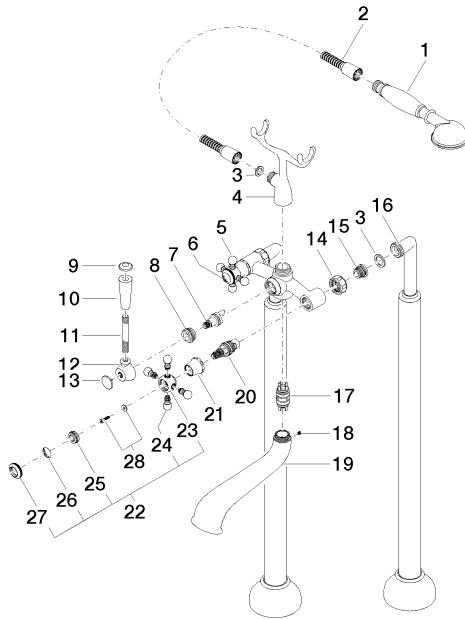



MADISON Two-hole bath mixer for free-standing assembly with hand shower set - Brushed Dark Platinum

MADISON

25 943 360

Spare parts list

No.	Item Number	Name	Quantity used	Delivery time
	28 002 970-99	MADISON Metal hand shower with porcelain insert (white) - Brushed Dark Platinum	43	30