

## TARA Showerpipe without hand shower FlowReduce 220 mm - Brushed Dark Platinum

26 633 892 Product version from 4/1/2024



- shower with fixed riser projection 420mm
- overhead shower: rain flow
- rain shower Ø 220 mm
- rain shower with anti-scale system
- max. rainshower flow 7 l/min
- rotary diverter for fixed-riser shower/hand shower
- height of fittings up to rain shower (bottom edge) 1007mm
- height of fittings up to top edge of elbow 1167mm
- rosette for shower holder Ø 55mm
- rosette for wall mounting Ø 57mm
- rosette for shower mixer Ø 65mm
- gauge 150 mm - 13 mm
- 1500 mm metal shower hose
- 1/2" connection
- Pipe diameter 20 mm
- quick clearing
- This product can help a building meet the requirements of Green Building Rating Systems, e.g. LEED®, BREEAM®, DGNB
- WRAS

This article does not include a hand shower!

Intrinsic protection against back flow.

	Brushed Dark Platinum	26 633 892-99
	Chrome	26 633 892-00
	Brushed Platinum	26 633 892-06
	Platinum	26 633 892-08
	Dark Chrome	26 633 892-19
	Brushed Durabronze (23kt Gold)	26 633 892-28
	Matte Black	26 633 892-33
	Brushed Bronze	26 633 892-42
	Brushed Champagne (22kt Gold)	26 633 892-46
	Champagne (22kt Gold)	26 633 892-47
	Brushed Chrome	26 633 892-93



## TARA Showerpipe without hand shower FlowReduce 220 mm - Brushed Dark Platinum

26 633 892 Product version from 4/1/2024

### Required miscellaneous

	<b>Hand shower - Brushed Dark Platinum</b>	28 015 979-99
---	--	---------------

### Required miscellaneous

	<b>Hand shower FlowReduce - Brushed Dark Platinum</b>	28 012 979-99 0010
---	---	-----------------------

### Required miscellaneous

	<b>Hand shower - Brushed Dark Platinum</b>	28 016 979-99
---	--	---------------

### Required miscellaneous

	<b>Hand shower - Brushed Dark Platinum</b>	28 018 979-99
---	--	---------------

### Required miscellaneous

	<b>SERIES-VARIOUS Hand shower FlowReduce - Brushed Dark Platinum</b>	28 029 979-99 0010
---	--	-----------------------

### Required miscellaneous

	<b>SERIES-VARIOUS Hand shower FlowReduce - Brushed Dark Platinum</b>	28 027 979-99 0010
---	--	-----------------------

### Required miscellaneous

	<b>Hand shower FlowReduce - Brushed Dark Platinum</b>	28 016 979-99 0010
---	---	-----------------------

### Required miscellaneous

	<b>Hand shower - Brushed Dark Platinum</b>	28 017 979-99
---	--	---------------

### Required miscellaneous

	<b>Hand shower - Brushed Dark Platinum</b>	28 012 979-99
---	--	---------------

### Required miscellaneous

	<b>Hand shower FlowReduce - Brushed Dark Platinum</b>	28 018 979-99 0010
---	---	-----------------------

### Required miscellaneous

	<b>SERIES-VARIOUS Hand shower FlowReduce - Brushed Dark Platinum</b>	28 025 979-99 0010
---	--	-----------------------



# TARA Showerpipe without hand shower FlowReduce 220 mm - Brushed Dark Platinum

---

26 633 892 Product version from 4/1/2024

## Flow rate chart

---

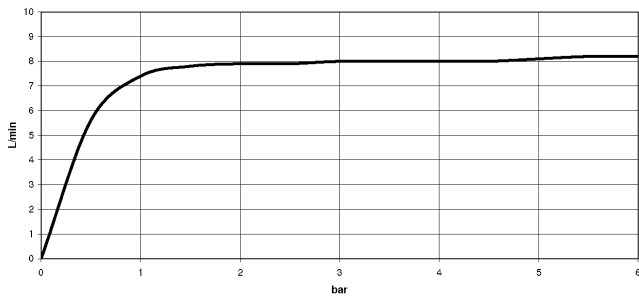

## Codes & Standards

---

DIN 4109

EN 1717

ISO 3822

Scottish Water  
Byelaws

UK Water Supply  
Regulations

Ü-Zeichen



## TARA Showerpipe without hand shower FlowReduce 220 mm - Brushed Dark Platinum

---

26 633 892 Product version from 4/1/2024

### Certificates

---

Belgaqua\_21-023-2 WRAS\_2204

LGA\_38

**TARA Showerpipe without hand shower FlowReduce 220 mm - Brushed Dark Platinum**

26 633 892 Product version from 4/1/2024

Parts for other finishes can be found here: [Chrome](#)

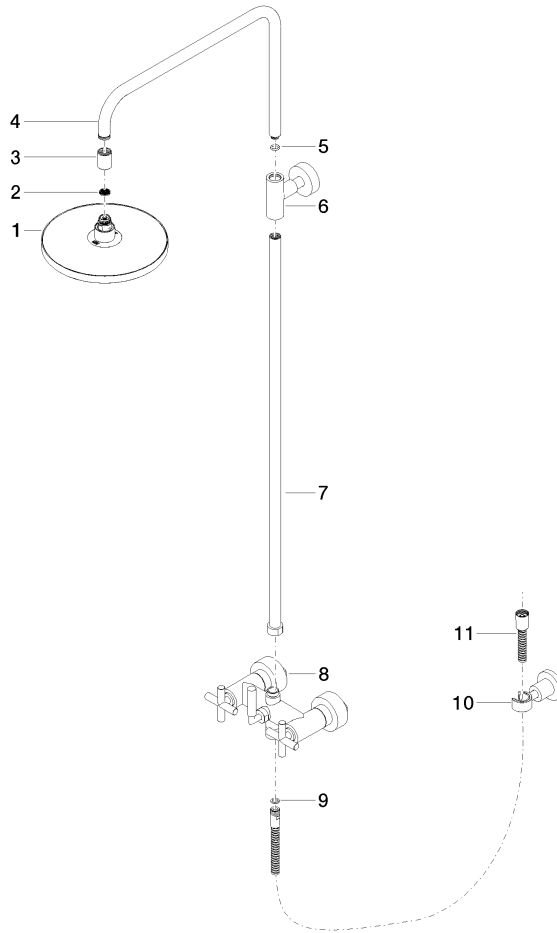

**Spare parts list**

No.	Item Number	Name	Quantity used	Delivery time
1	90 12 05 092 20-99	shower	1	20
2	09 23 01 039 90	sieve	1	2
3	09 24 03 177 20-99	adaptor	1	20
4	04 28 22 101 20-99	spout	1	20
5	90 14 10 011 00 90	seal	1	2
6	90 17 11 037 00-99	holder	1	20
7	90 28 22 096 00-99	pipe	1	20
8	04 17 10 020 01-99	fitting	1	20
9	90 14 20 026 00 90	seal	1	2
10	28 050 892-99	TARA Wall bracket - Brushed Dark Platinum	1	20
11	28 304 970-99	Metal shower hose 1/2" x 3/8" x 1500 mm - Brushed Dark Platinum	1	20