







30 010 662



- 126mm projection
- fixed spout
- circular, air-enriched flow
- hole diameter 35 mm
- rosette Ø 60 mm
- max. flow 5.7 l/min
- lead-free
- This product can help a building meet the requirements of Green Building Rating Systems, e.g. LEED®, BREEAM®, DGNB

	Brushed Platinum	30 010 662-06
	Chrome	30 010 662-00
	Dark Chrome	30 010 662-19
	Light Gold	30 010 662-26
	Brushed Light Gold	30 010 662-27
	Matte Black	30 010 662-33
	Brushed Bronze	30 010 662-42
	Brushed Champagne (22kt Gold)	30 010 662-46
	Champagne (22kt Gold)	30 010 662-47
	Brushed Chrome	30 010 662-93
	Brushed Dark Platinum	30 010 662-99

Recommended miscellaneous



- Concealed wall elbow -** 35 085 970 90
- max. recess depth 163 mm
  - min. recess depth 90 mm

30 010 662

mm [inches]

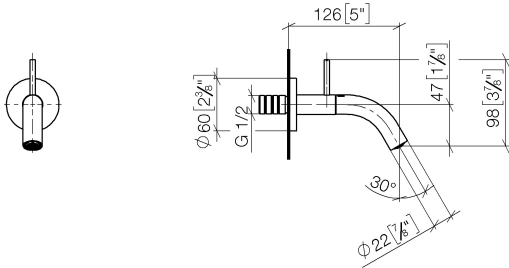

**Flow rate chart**



**Codes & Standards**

DIN 4109

ISO 3822

Ü-Zeichen



## META Wall-mounted valve cold water without pop-up waste - Brushed Platinum

---

META

30 010 662

Certificates

---

LGA\_38

30 010 662

Product version from 5/1/2022

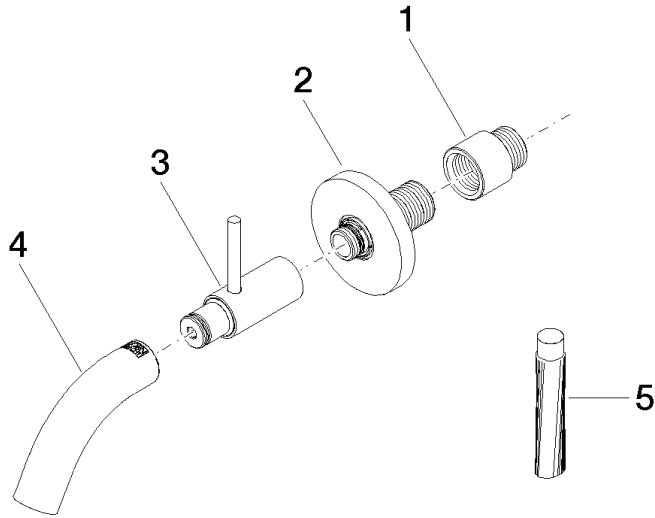



**META Wall-mounted valve cold water without pop-up waste - Brushed Platinum**

META

30 010 662

**Spare parts list**

**Product version from 5/1/2022**

No.	Item Number	Name	Quantity used	Delivery time
	09 24 03 072 10 90	nipple	5	2