

META Single-lever basin mixer with pop-up waste - Brushed Champagne (22kt Gold)











META

33 501 660



- 125mm projection
- fixed spout
- circular, air-enriched flow
- height of mixer 133 mm
- height up to aerator 52 mm
- hole diameter 35 mm
- 2x screw-in M 8 x 1 pressure hose, leak-tested
- max. flow 5.7 l/min
- lead-free
- This product can help a building meet the requirements of Green Building Rating Systems, e.g. LEED®, BREEAM®, DGNB
- WRAS 2003058

Only suitable for basins with an overflow.

	Brushed Champagne (22kt Gold)	33 501 660-46
	Chrome	33 501 660-00
	Brushed Platinum	33 501 660-06
	Dark Chrome	33 501 660-19
	Light Gold	33 501 660-26
	Brushed Light Gold	33 501 660-27
	Matte Black	33 501 660-33
	Brushed Bronze	33 501 660-42
	Champagne (22kt Gold)	33 501 660-47
	Brushed Chrome	33 501 660-93
	Brushed Dark Platinum	33 501 660-99

33 501 660

mm [inches]

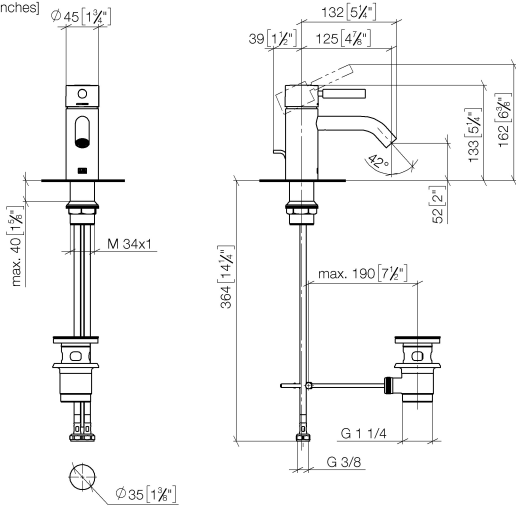

Flow rate chart

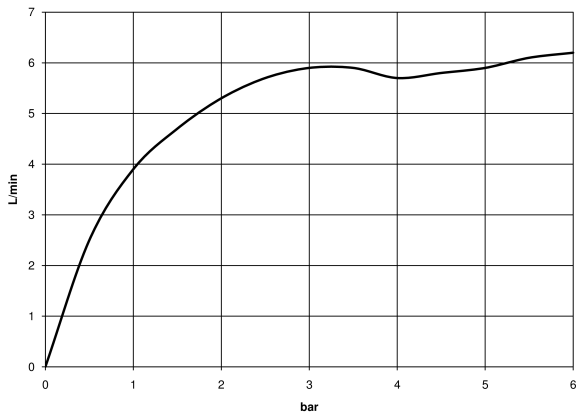

33 501 660
Parts for other
finishes can be found
here: [Chrome](#)

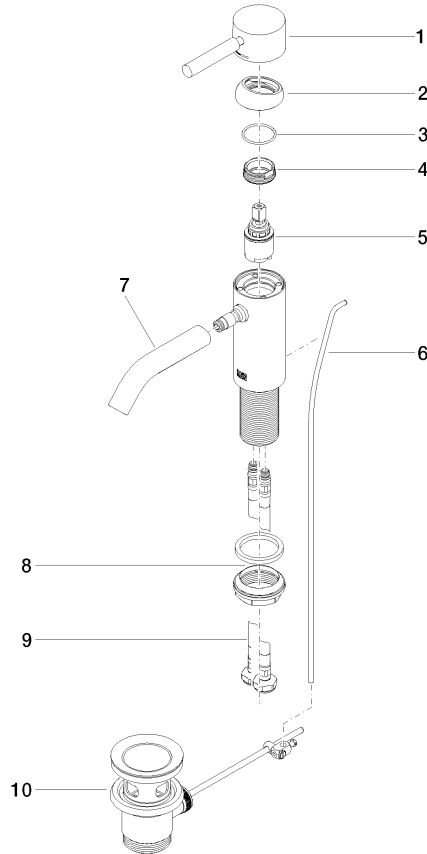

Spare parts list

No.	Item Number	Name	Quantity used	Delivery time
1	90 20 66 002 00-46	handle	1	30
2	09 28 30 041-46	cover	1	30
3	09 14 10 091 90	seal	1	2
4	09 24 04 266 90	nut	1	2
5	90 15 05 044 00 90	cartridge	1	2
6	09 31 09 110-46	pull-rod	1	60
7	90 11 06 206 00-46	spout	1	30
8	04 23 10 044 07 90	fixing set	1	2
9	04 30 04 100 00 90	hose	2	2
10	90 11 01 001 00-46	pop-up waste	1	30