







33 521 705



- 173mm projection
- fixed spout
- rectangular spray pattern with 40 individual jets
- height of mixer 226 mm
- base 56 x 52mm
- height up to aerator 212 mm
- hole diameter 35 mm
- 2x screw-in M 8 x 1 pressure hose, leak-tested
- max. flow 4 l/min
- lead-free
- WRAS 1612021
- This product can help a building meet the requirements of Green Building Rating Systems, e.g. LEED®, BREEAM®, DGNB

	Dark Chrome	33 521 705-19
	Chrome	33 521 705-00
	Brushed Platinum	33 521 705-06
	Brushed Champagne (22kt Gold)	33 521 705-46
	Champagne (22kt Gold)	33 521 705-47
	Brushed Dark Platinum	33 521 705-99

33 521 705

mm [inches]

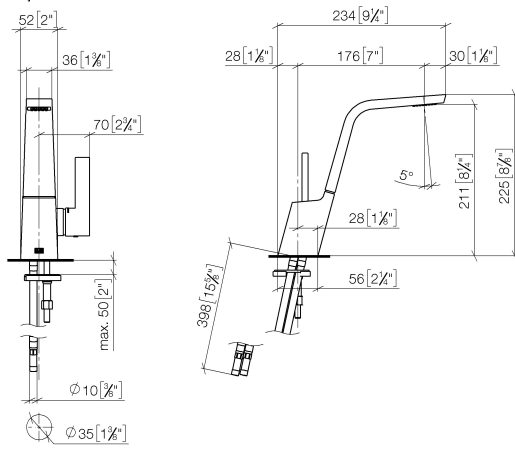

Flow rate chart

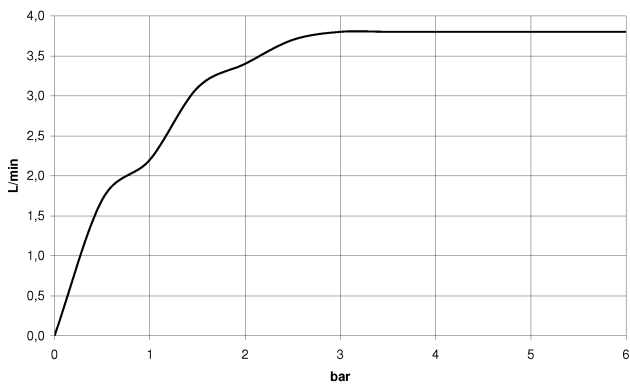

Certificates

GDV_0400279.

33 521 705

Parts for other
finishes can be found
here: [Chrome](#)

