











33 800 875



- 201mm projection
- pivotable spout 360°
- air-enriched flow
- height of mixer 373 mm
- height up to aerator 240 mm
- hole diameter 35 mm
- max. flow 8 l/min at 3 bar flow pressure
- lead-free
- This product can help a building meet the requirements of Green Building Rating Systems, e.g. LEED®, BREEAM®, DGNB
- WRAS 2101012

	Brushed Champagne (22kt Gold)	33 800 875-46
	Chrome	33 800 875-00
	Brushed Platinum	33 800 875-06
	Platinum	33 800 875-08
	Durabrand (23kt Gold)	33 800 875-09
	Dark Chrome	33 800 875-19
	Brushed Durabrand (23kt Gold)	33 800 875-28
	Matte Black	33 800 875-33
	Champagne (22kt Gold)	33 800 875-47
	Brushed Chrome	33 800 875-93
	Brushed Dark Platinum	33 800 875-99

Recommended miscellaneous

**Dispenser without rosette -
Brushed Champagne (22kt Gold)** 82 424 970-46



Recommended miscellaneous

**Strainer waste with control handle -
Brushed Champagne (22kt Gold)** 10 712 970-46



33 800 875

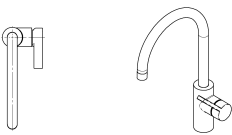
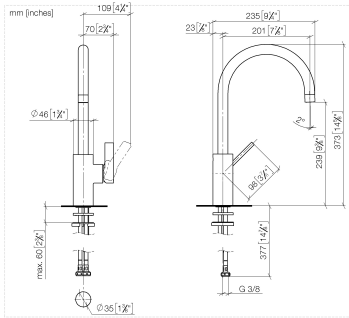

Flow rate chart



Codes & Standards

DIN 4109

Executive Order
no. 1007

ISO 3822

Ü-Zeichen



TARA ULTRA Single-lever mixer - Brushed Champagne (22kt Gold)

TARA ULTRA

33 800 875

Certificates

GDV_0400

LGA_18

33 800 875

Product version from 6/1/2022

Parts for other finishes can be found here: [Chrome](#)

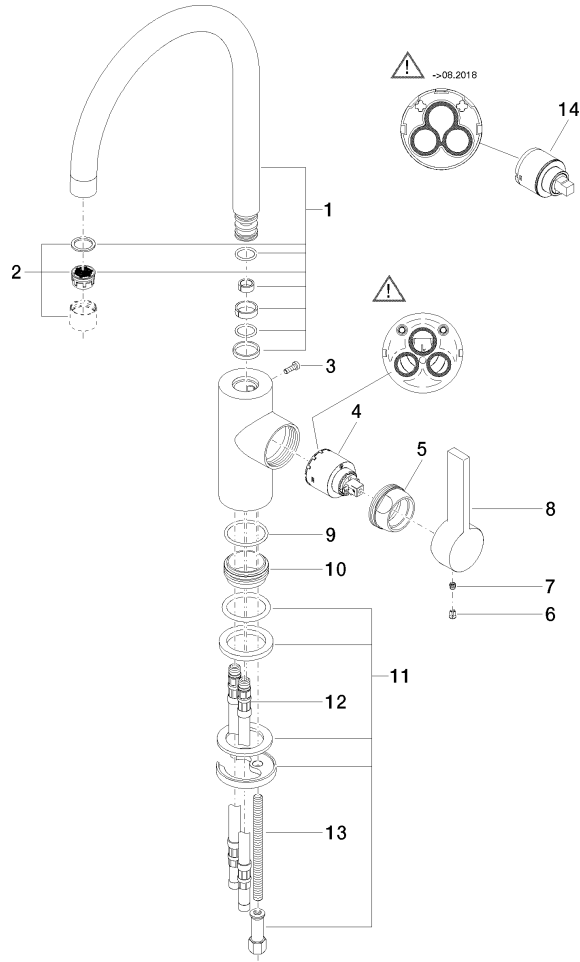



TARA ULTRA Single-lever mixer - Brushed Champagne (22kt Gold)

TARA ULTRA

33 800 875

Spare parts list

Product version from 6/1/2022