













Concealed single-lever mixer with cover plate - Brushed Dark Platinum

36 060 660 Product version from 6/29/2020



- cover plate Ø 78 mm
- WRAS

	Brushed Dark Platinum	36 060 660-99
	Chrome	36 060 660-00
	Brushed Platinum	36 060 660-06
	Platinum	36 060 660-08
	Dark Chrome	36 060 660-19
	Light Gold	36 060 660-26
	Brushed Light Gold	36 060 660-27
	Brushed Durabronze (23kt Gold)	36 060 660-28
	Matte Black	36 060 660-33
	Brushed Bronze	36 060 660-42
	Brushed Champagne (22kt Gold)	36 060 660-46
	Champagne (22kt Gold)	36 060 660-47
	Brushed Chrome	36 060 660-93

Required miscellaneous



Concealed wall-mounted single-lever mixer - 35 860 970 90

- max. recess depth mm
- min. recess depth mm



Concealed single-lever mixer with cover plate - Brushed Dark Platinum

36 060 660 Product version from 6/29/2020

mm [inches]

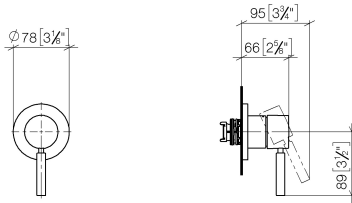

Codes & Standards

DIN 4109

ISO 3822

Scottish Water
Byelaws

UK Water Supply
Regulations

Ü-Zeichen

Certificates

WRAS_2107

LGA_29

Concealed single-lever mixer with cover plate - Brushed Dark Platinum

36 060 660 Product version from 6/29/2020

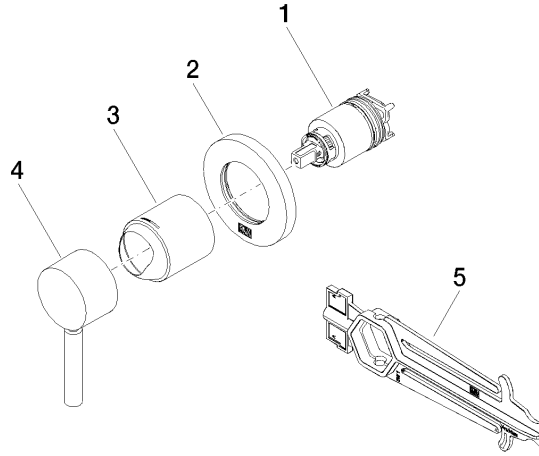

Spare parts list

No.	Item Number	Name	Quantity used	Delivery time
1	90 15 05 064 01 90	cartridge	1	2
2	90 27 66 009 00-99	rosette	1	20
3	09 11 02 293-99	cover	1	20
4	90 20 66 006 00-99	handle	1	20
5	90 30 09 064 00 90	key	1	2