



EDITION PRO Concealed single-lever mixer with diverter - Chrome

36 120 626



- automatic diverter
- cover plate Ø 150 mm
- WRAS 2207012

	Chrome	36 120 626-00
	Matte Black	36 120 626-33
	Brushed Chrome	36 120 626-93

Required miscellaneous



EDITION PRO Concealed single-lever mixer - 35 070 970 90
 •max. recess depth 105 mm
 •min. recess depth 80 mm

Required miscellaneous

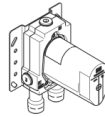

EDITION PRO Concealed single-lever mixer with backflow preventor - 35 071 970 90
 •max. recess depth 105 mm
 •recess depth 80mm

EDITION PRO Concealed single-lever mixer with diverter - Chrome

36 120 626

mm [inches]

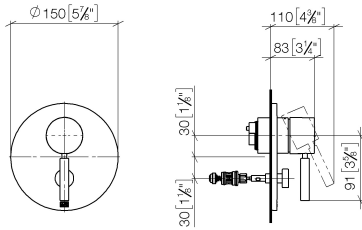

Flow rate chart

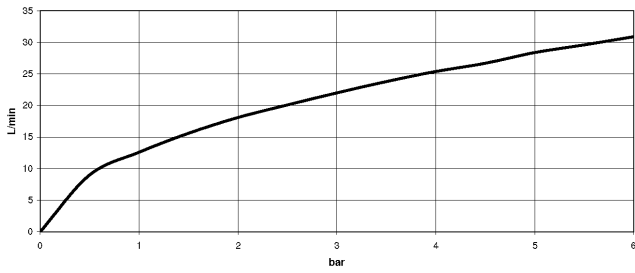

Codes & Standards

DIN 4109

ISO 3822

Scottish Water
Byelaws

UK Water Supply
Regulations

Ü-Zeichen



EDITION PRO Concealed single-lever mixer with diverter - Chrome

36 120 626

Certificates

WRAS_2207

LGA_19

EDITION PRO Concealed single-lever mixer with diverter - Chrome

36 120 626

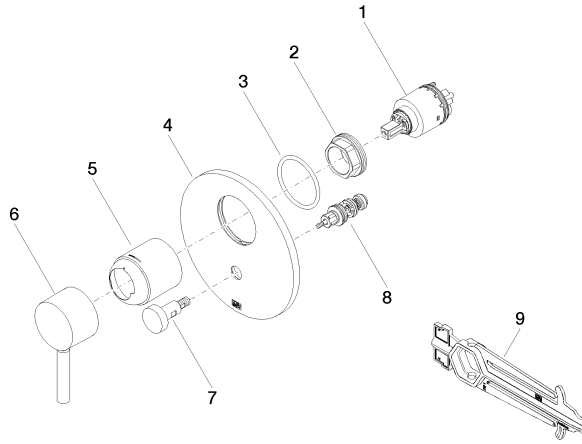



EDITION PRO Concealed single-lever mixer with diverter - Chrome

36 120 626

Spare parts list

No.	Item Number	Name	Quantity used	Delivery time
	90 15 05 039 00 90	cartridge	9	2