

36 515 979













Fits: IMO, LULU, MADISON, MEM, TARA, CL.1, LISSÉ, VAIA, META, CYO

- HORIZONTAL RAIN, max. flow rate 6 l/min (at 3 bar)
- with anti-scale system
- cover plate 120 x 120 mm
- This product can help a building meet the requirements of Green Building Rating Systems, e.g. LEED®, BREEAM®, DGNB
- WRAS 1304001

**Flow restrictor (8.3 l/min) to extend shower jet from approx. 500 mm to approx. 1000 mm**

Flow restrictor (8.3 l/min) to extend shower jet from approx. 500 mm to approx. 1000 mm

	Brushed Bronze	36 515 979-42
	Chrome	36 515 979-00
	Brushed Platinum	36 515 979-06
	Platinum	36 515 979-08
	Dark Chrome	36 515 979-19
	Light Gold	36 515 979-26
	Brushed Light Gold	36 515 979-27
	Brushed Durabronze (23kt Gold)	36 515 979-28
	Matte Black	36 515 979-33
	Brushed Champagne (22kt Gold)	36 515 979-46
	Champagne (22kt Gold)	36 515 979-47
	Brushed Chrome	36 515 979-93
	Brushed Dark Platinum	36 515 979-99

**Required miscellaneous**



**WATER POINTS Adapter plate -** 12 305 970 90

**Required miscellaneous**



**Concealed wall installation box -** 35 205 970 90  
 ● min. recess depth 85 mm  
 ● max. recess depth 110 mm

**Recommended miscellaneous**



**xGRID Attachment set for integrating in the dry wall construction -** 12 340 970 90

**Required miscellaneous**



**xGRID Installation track 555 mm -** 12 360 970 90

36 515 979

mm [inches]

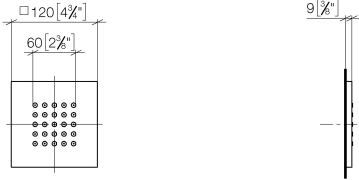

**Flow rate chart**

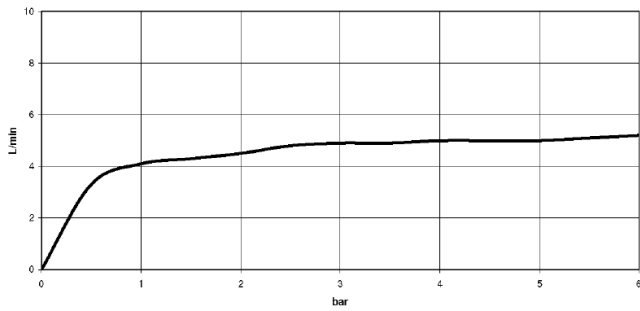

**Trajectory diagram**

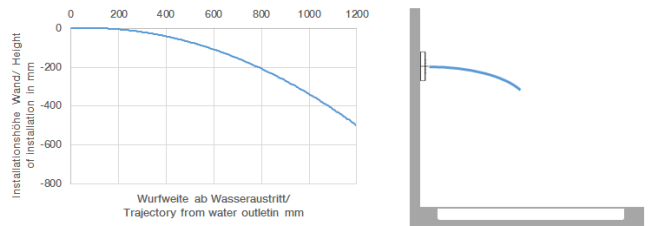

**Codes & Standards**

DIN 4109

ISO 3822

Ü-Zeichen



WATER POINTS Concealed body spray FlowReduce - Brushed Bronze

---

IMO

36 515 979

Certificates

---

LGA\_18

36 515 979

Product version from 4/1/2024

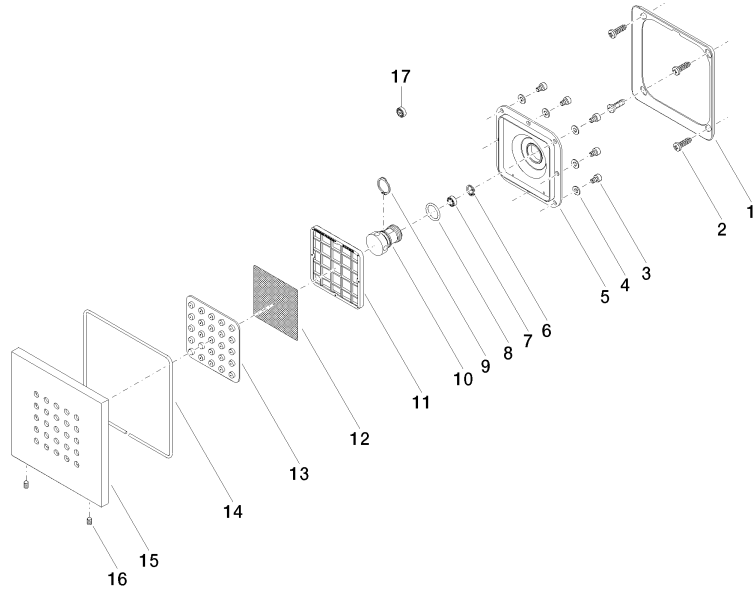



WATER POINTS Concealed body spray FlowReduce - Brushed Bronze

IMO

36 515 979

**Spare parts list**

**Product version from 4/1/2024**

No.	Item Number	Name	Quantity used	Delivery time
	09 28 01 024 90	holder	34	2