









36 607 985



- rosette 60 x 60 mm
- head part with cut-to-length spindle and sleeve
- WRAS 2011026, 2010066

	Dark Chrome	36 607 985-19
	Chrome	36 607 985-00
	Brushed Platinum	36 607 985-06
	Platinum	36 607 985-08
	Brushed Light Gold	36 607 985-27
	Brushed Durabronze (23kt Gold)	36 607 985-28
	Brushed Chrome	36 607 985-93
	Brushed Dark Platinum	36 607 985-99



SYMETRICS Wall valve anti-clockwise closing 1/2" - Dark Chrome

IMO

36 607 985

mm [inches]

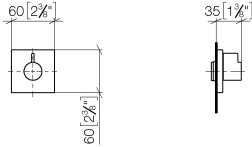

Codes & Standards

DIN 4109	EN 1111	ISO 3822	Scottish Water Byelaws
UK Water Supply Regulations	Ü-Zeichen		

Certificates

WRAS_2010	LGA_29	DVGW_DW-6512DNO	WRAS_2011
-----------	--------	-----------------	-----------

36 607 985

Parts for other
finishes can be found
here: [Chrome](#)

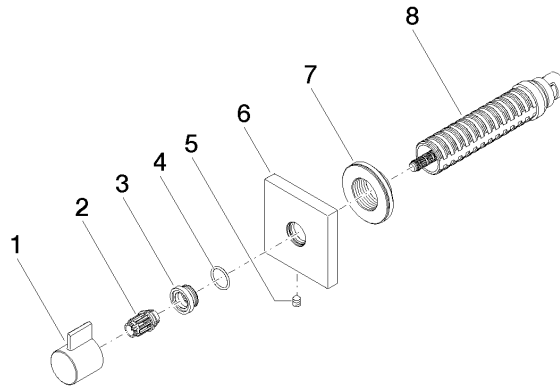



SYMETRICS Wall valve anti-clockwise closing 1/2" - Dark Chrome

IMO

36 607 985

Spare parts list