







ST 060 113 3985



- cover plate 120 x 120 mm
- rosette 60 x 60 mm
- temperature control handle with safety limit stop at 38°C
- thermostat cartridge
- 3x head part with cut-to-length spindle and sleeve

	Brushed Light Gold	ST 060 113 3985-27
	Chrome	ST 060 113 3985-00
	Brushed Platinum	ST 060 113 3985-06
	Platinum	ST 060 113 3985-08
	Brushed Durabronze (23kt Gold)	ST 060 113 3985-28
	Brushed Chrome	ST 060 113 3985-93
	Brushed Dark Platinum	ST 060 113 3985-99

**Individual components of this set**

You need the following components for this set

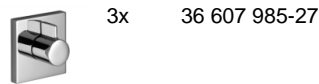
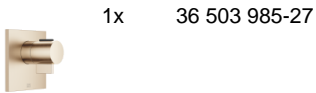



# SYMETRICS xTOOL Thermostat module - Brushed Light Gold

---

IMO

ST 060 113 3985

ST 060 113 3985



- cover plate 120 x 120 mm
- temperature control handle with safety limit stop at 38°C
- thermostat cartridge

Fits: IMO, MEM, CL.1, CYO

	Brushed Light Gold	36 503 985-27
	Chrome	36 503 985-00
	Brushed Platinum	36 503 985-06
	Platinum	36 503 985-08
	Dark Chrome	36 503 985-19
	Brushed Durabronze (23kt Gold)	36 503 985-28
	Matte Black	36 503 985-33
	Brushed Champagne (22kt Gold)	36 503 985-46
	Champagne (22kt Gold)	36 503 985-47
	Brushed Chrome	36 503 985-93
	Brushed Dark Platinum	36 503 985-99

**Required miscellaneous**



**xTOOL Concealed thermostat module without volume control -** 35 503 970 90  
 • min. recess depth 95 mm  
 • max. recess depth 160 mm

**Recommended miscellaneous**



**xGRID Attachment set for integrating in the dry wall construction -** 12 340 970 90

**Required miscellaneous**



**xGRID Installation track 555 mm -** 12 360 970 90

ST 060 113 3985

mm [inches]

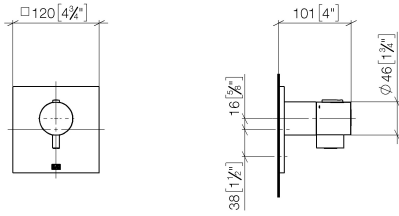

**Flow rate chart**

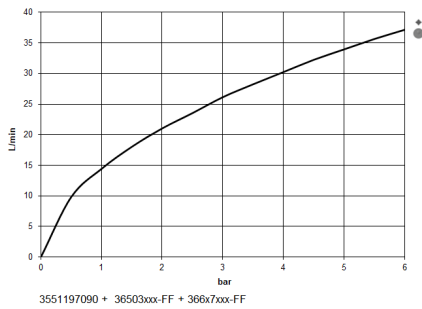

**Certificates**

WRAS\_2011026.





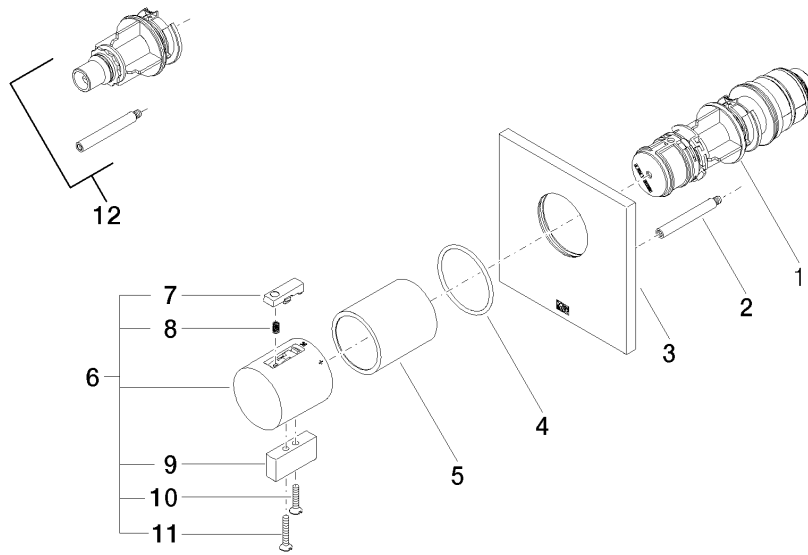

DVGW\_DW-  
6512DN0706.

LGA\_29930.

ST 060 113 3985



- rosette 60 x 60 mm
- head part with cut-to-length spindle and sleeve

	Brushed Light Gold	36 607 985-27
	Chrome	36 607 985-00
	Brushed Platinum	36 607 985-06
	Platinum	36 607 985-08
	Brushed Durabronze (23kt Gold)	36 607 985-28
	Brushed Chrome	36 607 985-93
	Brushed Dark Platinum	36 607 985-99



# SYMETRICS xTOOL Thermostat module - Brushed Light Gold

---

IMO

ST 060 113 3985

ST 060 113 3985

mm [inches]

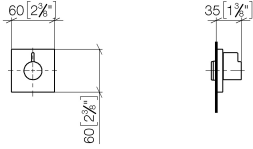

Certificates

WRAS\_2011026.

LGA\_29931.

WRAS\_2010066.

DVGW\_DW-  
6512DN0706.

ST 060 113 3985

Parts for other finishes can be found here: [Chrome](#)

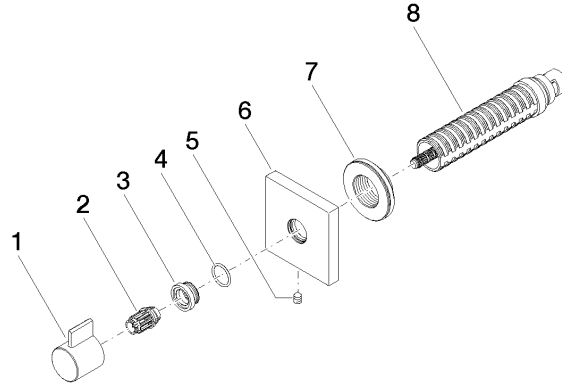

**Spare parts list**

No.	Item Number	Name	Quantity used	Delivery time
1	09 20 98 002-27	handle	1	60
2	09 12 12 005 90	fixing cap	1	2
3	09 12 12 043-27	base	1	60
4	09 14 10 017 90	seal	1	2
5	90 31 11 004 00 90	pin	1	2
6	09 27 98 014-27	rosette	1	60
7	09 21 02 151 90	sleeve	1	2
8	90 90 03 202 00 90	top	1	2