







28 450 410



- Salida ducha de 1/2"
- Roseta Ø 55 mm
- Racor 1/2"

Protección contra reflujo.

	Platino cepillado	28 450 410-06
	Cromo	28 450 410-00
	Platino	28 450 410-08
	Latón (Oro 23k)	28 450 410-09
	Latón cepillado (Oro 23k)	28 450 410-28
	Dark Platinum cepillado	28 450 410-99

Complementos recomendados



- Cuerpo empotrado -** 35 085 970 90
- Profundidad de montaje mín. 90 mm
 - Profundidad de montaje máx. 163 mm

28 450 410

mm [inches]



Diagrama de flujo



Certificado

Belgaqua_21-381- WRAS_240502026.
27_7.

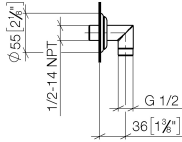
28 450 410

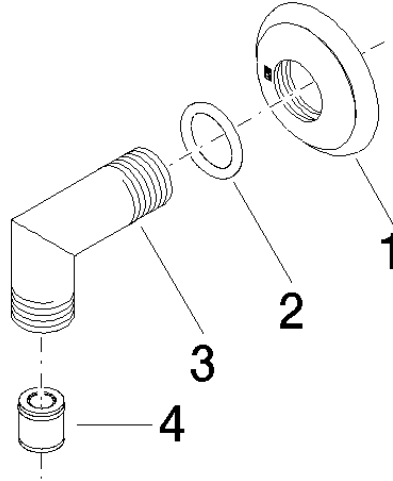

Lista de piezas de recambios

N°	Número de artículo	Denominación	Cantidad de montaje	Plazo de entrega
1	09 27 35 003-06	roseta	1	10
2	90 14 10 026 00 90	sello	1	2
3	09 11 03 121-06	racor	1	10
4	90 23 01 141 00 90	inhibidor de reflujo	1	2