

**LISSÉ Monomando de bañera para montaje a pared sin juego de ducha -
Negro mate**







LISSÉ

33 200 845



- Saliente 190-200 mm
- Chorro normal redondo
- Inversor bañera/ducha
- Salida ducha de 3/8"
- Rosetas corredizas Ø 60 mm
- Racor 1/2"
- Calibración 150 mm ± 15 mm
- Caudal máx. 13,5 l/min con 3 bares de presión hidráulica

Protección contra reflujo.

	Negro mate	33 200 845-33
	Cromo	33 200 845-00
	Platino cepillado	33 200 845-06
	Dark Chrome	33 200 845-19
	Cromo cepillado	33 200 845-93
	Dark Platinum cepillado	33 200 845-99

33 200 845

mm [inches]



Diagrama de flujo



Certificado

LGA_9603.

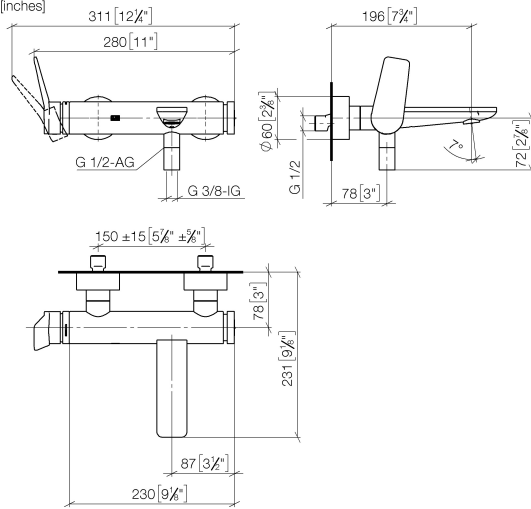
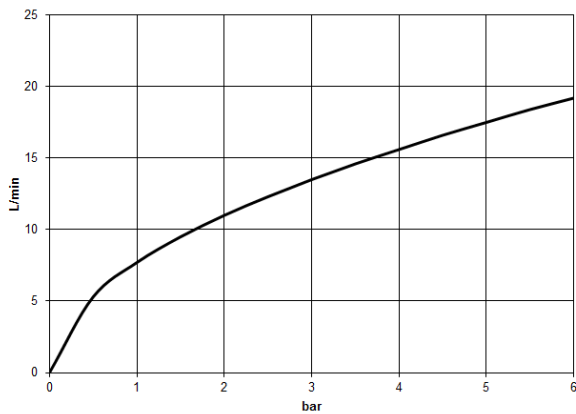
WRAS_2311042.

**LISSÉ Monomando de bañera para montaje a pared sin juego de ducha -
Negro mate**

LISSÉ

33 200 845

Piezas para otros
acabados pueden
encontrarse aquí:
Cromo

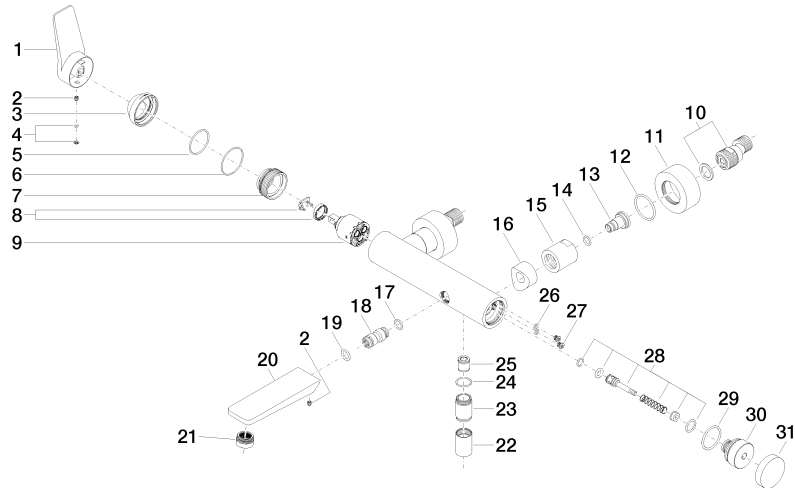

33 200 845

Lista de piezas de recambios

Nº	Número de artículo	Denominación	Cantidad de montaje	Plazo de entrega
1	09 20 84 021-33	manilla	1	30
2	90 31 11 030 00 90	varilla	2	2
3	09 28 30 032-33	funda	1	30
4	90 31 20 087 00-33	tapón	1	30
5	09 14 10 102 90	sello	1	2
6	09 14 10 190 90	sello	1	2
7	09 24 04 296 90	tuerca	1	2
8	90 28 10 148 00 90	accessorio	1	2
9	90 15 05 064 00 90	cartucho	1	2
10	04 11 04 030 00 90	racor	2	2
11	09 27 62 004-33	roseta	2	30
12	09 14 10 119 90	sello	2	2
13	09 29 05 005 20 90	boquilla	2	60
14	09 14 10 008 90	sello	2	2
15	09 23 10 048-33	tuerca	2	30
16	09 18 40 059-33	camisa	2	30
17	09 14 10 003 90	sello	1	2
18	09 24 04 043 90	boquilla	1	2
19	90 14 10 011 00 90	sello	1	2
20	09 11 84 012-33	caño	1	30
21	90 23 01 161 00-33	mezclador de aire	1	30
22	90 21 02 069 00-33	funda	1	30
23	09 24 03 115 20-33	boquilla	1	30
24	90 14 10 032 00 90	sello	1	2
25	90 23 01 141 00 90	inhibidor de reflujo	1	2
26	09 14 10 001 90	sello	2	2
27	09 30 30 113 20 90	tornillo	2	2
28	90 31 09 032 00-33	inversor	1	-
Ya no se puede pedir el repuesto, solicite el artículo de repuesto.				
29	09 14 10 101 90	sello	1	2
30	09 21 10 035 20-33	boquilla	1	30
31	09 20 62 031-33	manilla	1	30