





33 600 845



- Saliente 123 mm
- Articulación esférica giratoria 30°
- Aireador rectangular
- Altura máxima del conjunto 127 mm
- Altura hasta el aireador 83 mm
- Diámetro del orificio 35 mm
- 2x Latiguillo de presión M 8 x 1 enroscado, estanqueidad probada
- Caudal máx. 6 l/min

	Dark Platinum cepillado	33 600 845-99
	Cromo	33 600 845-00
	Platino cepillado	33 600 845-06
	Dark Chrome	33 600 845-19
	Cromo cepillado	33 600 845-93

Complementos necesarios



Latiguillo de presión 3/8" - 04 30 04 102
 •Pida dos mangueras de presión adicionales (solo para USA) 00 90

33 600 845



Diagrama de flujo



Certificado

LGA_29009.

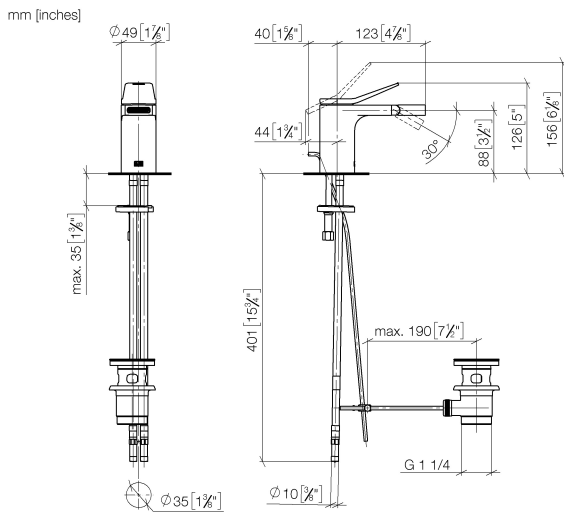
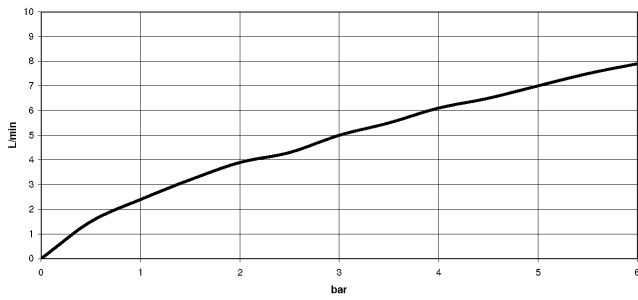
WRAS_240202012.

33 600 845

