







36 201 705

- Inversor giratorio
- Roseta 60 x 60 mm



| | | |
|---|-------------------------------|---------------|
|  | Dark Chrome | 36 201 705-19 |
|  | Cromo | 36 201 705-00 |
|  | Platino cepillado | 36 201 705-06 |
|  | Champagne cepillado (Oro 22k) | 36 201 705-46 |
|  | Champagne (Oro 22k) | 36 201 705-47 |
|  | Dark Platinum cepillado | 36 201 705-99 |

36 201 705

mm [inches]



Diagrama de flujo



Certificado

LGA_38379.

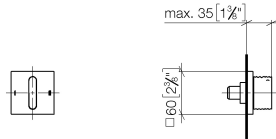
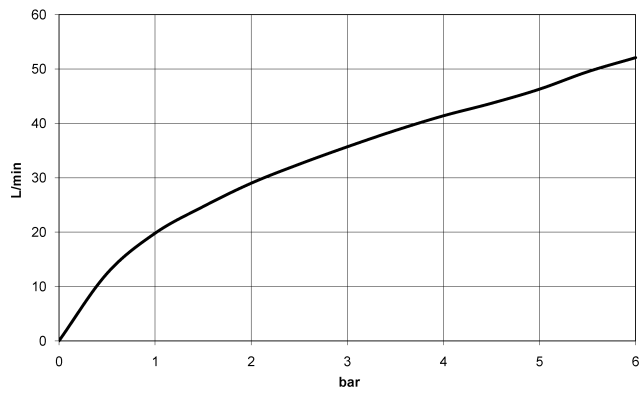
WRAS_2307045.

36 201 705

Piezas para otros acabados pueden encontrarse aquí:
Cromo

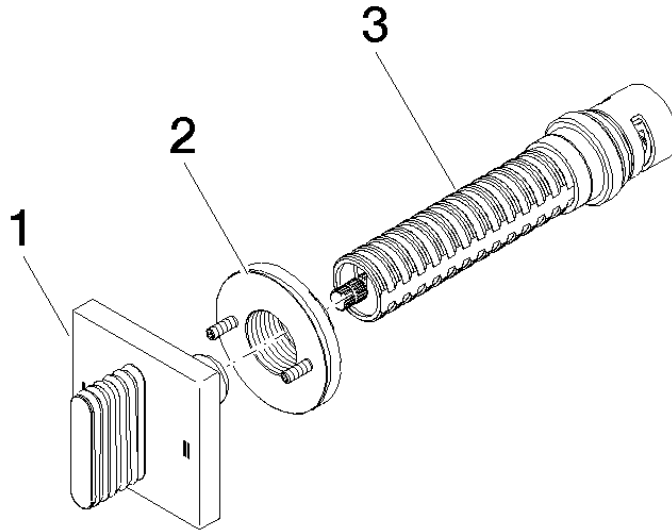

Lista de piezas de recambios

| Nº | Número de artículo | Denominación | Cantidad de montaje | Plazo de entrega |
|---|--------------------|--------------|---------------------|------------------|
| 1 | 90 20 70 055 08-19 | manilla | 1 | - |
| Ya no se puede pedir el repuesto, solicite el artículo de repuesto. | | | | |
| 2 | 90 21 02 181 00 90 | disco | 1 | 2 |
| 3 | 90 90 03 304 10 90 | inversor | 1 | 2 |