







36 201 705

- Inversor giratorio
- Roseta 60 x 60 mm



	Champagne cepillado (Oro 22k)	36 201 705-46
	Cromo	36 201 705-00
	Platino cepillado	36 201 705-06
	Dark Chrome	36 201 705-19
	Champagne (Oro 22k)	36 201 705-47
	Dark Platinum cepillado	36 201 705-99

36 201 705

mm [inches]



Diagrama de flujo



Certificado

LGA_38379.

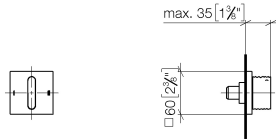
WRAS_2307045.

36 201 705

Piezas para otros acabados pueden encontrarse aquí:
Cromo

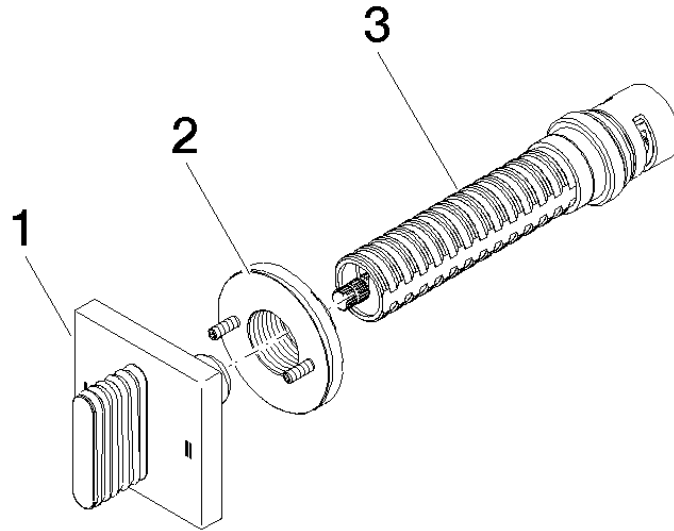

Lista de piezas de recambios

N°	Número de artículo	Denominación	Cantidad de montaje	Plazo de entrega
1	90 20 70 055 08-46	manilla	1	30
2	90 21 02 181 00 90	disco	1	2
3	90 90 03 304 10 90	inversor	1	2