







CL.1 Llave de paso empotrada cierre a la derecha frío 1/2" - Champagne (Oro 22k)

CL.1

36 607 706



- Roseta 60 x 60 mm
- Con distintivo fría
- Montura con husillo ajustable y camisa

	Champagne (Oro 22k)	36 607 706-47
	Cromo	36 607 706-00
	Platino cepillado	36 607 706-06
	Dark Chrome	36 607 706-19
	Champagne cepillado (Oro 22k)	36 607 706-46
	Dark Platinum cepillado	36 607 706-99

Complementos necesarios



- Válvula empotrada 1/2" -** 35 607 970 90
- Profundidad de montaje mín. 105 mm
 - Profundidad de montaje máx. 150 mm

36 607 706
mm [inches]



Certificado

LGA_29931.

WRAS_2010066.

36 607 706

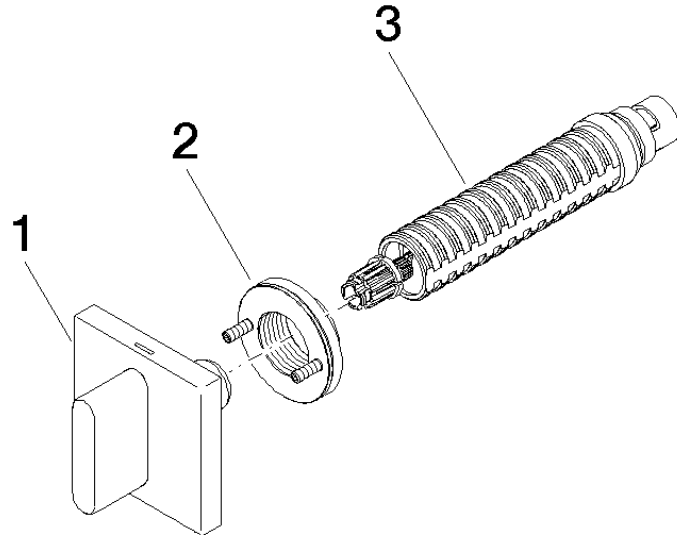

Lista de piezas de recambios

N°	Número de artículo	Denominación	Cantidad de montaje	Plazo de entrega
1	90 20 70 051 02-47	manilla (cold)	1	30
2	90 21 02 108 00 90	disco	1	2
3	90 90 03 143 00 90	parte superior	1	2