







CL.1 Llave de paso empotrada cierre a la izquierda caliente 1/2" - Platino cepillado

CL.1

36 617 707



- Con estructura WAVES
- Roseta 60 x 60 mm
- Con distintivo caliente
- Montura con husillo ajustable y camisa

	Platino cepillado	36 617 707-06
	Cromo	36 617 707-00
	Dark Chrome	36 617 707-19
	Champagne cepillado (Oro 22k)	36 617 707-46
	Champagne (Oro 22k)	36 617 707-47
	Dark Platinum cepillado	36 617 707-99

Complementos necesarios



- Válvula empotrada 1/2" - 35 607 970 90**
- Profundidad de montaje mín. 105 mm
 - Profundidad de montaje máx. 150 mm

CL.1 Llave de paso empotrada cierre a la izquierda caliente 1/2" - Platino
cepillado

CL.1

36 617 707
mm [inches]

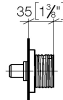
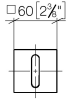

Certificado

DVGW_DW-
6501DN0116.

IAPMO_4976 (1).

LGA_29931.

WRAS_2010066.

LGA_29932.

36 617 707

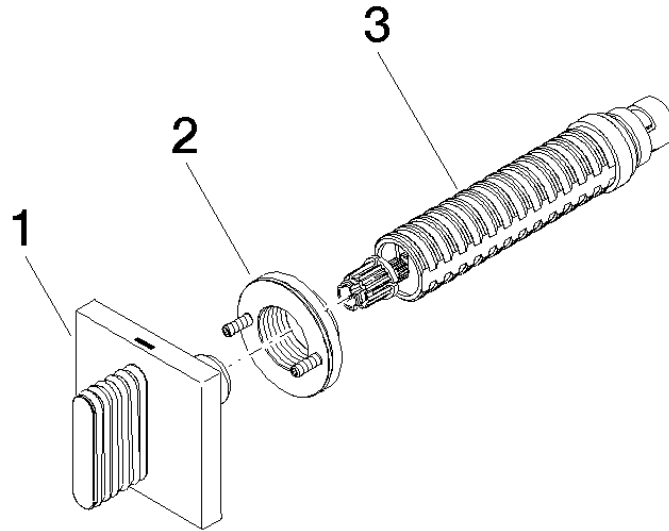

Lista de piezas de recambios

N°	Número de artículo	Denominación	Cantidad de montaje	Plazo de entrega
1	90 20 70 055 03-06	manilla (hot)	1	10
2	90 21 02 108 00 90	disco	1	2
3	90 90 03 142 00 90	parte superior	1	2