







36 627 706



- Con estructura CASCADA
- Roseta 60 x 60 mm
- Con distintivo fría
- Montura con husillo ajustable y camisa

	Platino cepillado	36 627 706-06
	Cromo	36 627 706-00
	Dark Chrome	36 627 706-19
	Champagne cepillado (Oro 22k)	36 627 706-46
	Champagne (Oro 22k)	36 627 706-47
	Dark Platinum cepillado	36 627 706-99

**Complementos necesarios**



- Válvula empotrada 1/2" -** 35 607 970 90
- Profundidad de montaje mín. 105 mm
  - Profundidad de montaje máx. 150 mm

36 627 706

mm [inches]

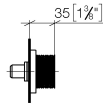
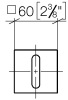

Certificado

DVGW\_DW-  
6501DN0116.

IAPMO\_4976 (1).

LGA\_29931.

WRAS\_2010066.

LGA\_29932.

36 627 706

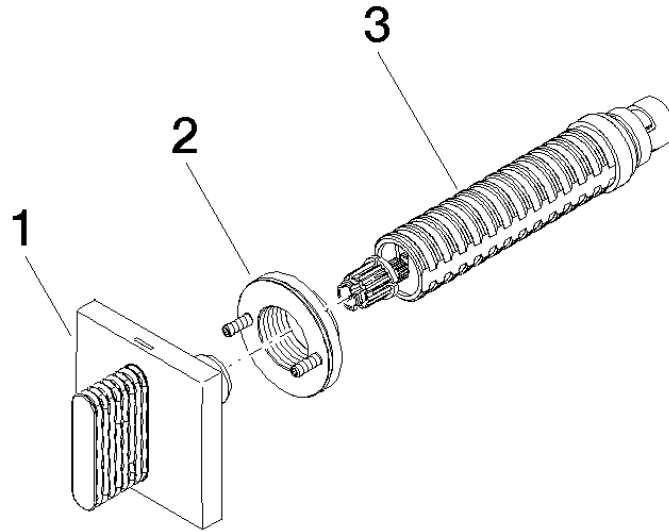

Lista de piezas de recambios

N°	Número de artículo	Denominación	Cantidad de montaje	Plazo de entrega
1	90 20 70 053 02-06	manilla ( cold )	1	10
2	90 21 02 108 00 90	disco	1	2
3	90 90 03 143 00 90	parte superior	1	2