







CL.1 Llave de paso empotrada cierre a la izquierda caliente 1/2" - Platino cepillado

CL.1

36 627 707



- Con estructura CASCADA
- Roseta 60 x 60 mm
- Con distintivo caliente
- Montura con husillo ajustable y camisa

	Platino cepillado	36 627 707-06
	Cromo	36 627 707-00
	Dark Chrome	36 627 707-19
	Champagne cepillado (Oro 22k)	36 627 707-46
	Champagne (Oro 22k)	36 627 707-47
	Dark Platinum cepillado	36 627 707-99

Complementos necesarios



- Válvula empotrada 1/2" -** 35 607 970 90
- Profundidad de montaje mín. 105 mm
 - Profundidad de montaje máx. 150 mm

CL.1 Llave de paso empotrada cierre a la izquierda caliente 1/2" - Platino
cepillado

CL.1

36 627 707
mm [inches]



Certificado

DVGW_DW-
6501DN0116.

IAPMO_4976 (1).

LGA_29931.

WRAS_2010066.

LGA_29932.

36 627 707

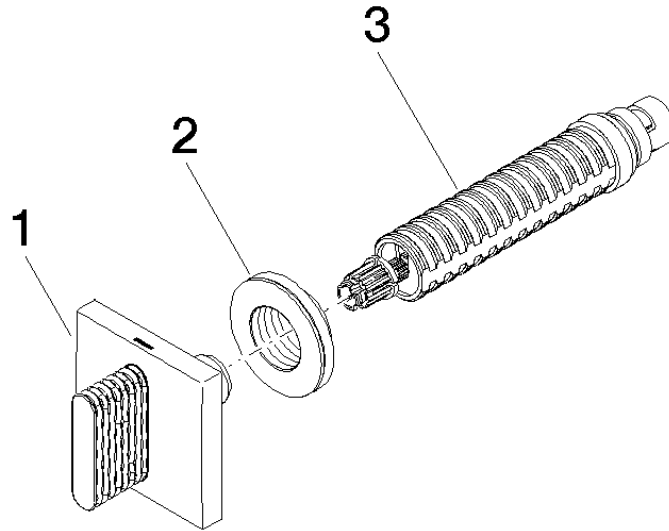

Lista de piezas de recambios

N°	Número de artículo	Denominación	Cantidad de montaje	Plazo de entrega
1	90 20 70 053 03-06	manilla (hot)	1	10
2	09 21 02 108 90	disco	1	60
3	90 90 03 142 00 90	parte superior	1	2