

ST 060 112 1360



- Roseta Ø 124 mm
- Roseta Ø 55 mm
- Maneta acanalada con tope de seguridad en 38°C
- Cartucho termostático
- 3x Montura con husillo ajustable y camisa

	Dark Platinum cepillado	ST 060 112 1360-99
	Cromo	ST 060 112 1360-00
	Platino cepillado	ST 060 112 1360-06
	Platino	ST 060 112 1360-08
	Latón (Oro 23k)	ST 060 112 1360-09
	Latón cepillado (Oro 23k)	ST 060 112 1360-28

Componentes individuales de este set

Necesita los siguientes componentes para este set



1x 36 503 977-99



3x 36 607 361-99



MADISON xTOOL Módulo termostático con tres llaves de paso - Dark Platinum
cepillado

MADISON

ST 060 112 1360

ST 060 112 1360



- Roseta Ø 124 mm
- Maneta acanalada con tope de seguridad en 38°C
- Cartucho termostático

	Dark Platinum cepillado	36 503 977-99
	Cromo	36 503 977-00
	Platino cepillado	36 503 977-06
	Platino	36 503 977-08
	Latón (Oro 23k)	36 503 977-09
	Latón cepillado (Oro 23k)	36 503 977-28

Complementos necesarios



xTOOL Módulo de termostato empotrado sin regulación de caudal - 35 503 970 90

- Profundidad de montaje mín. 85 mm
- Profundidad de montaje máx. 110 mm

Complementos recomendados



xGRID Juego de fijación para integración en obra en seco - 12 340 970 90

Complementos necesarios



xGRID Carril de montaje 555 mm - 12 360 970 90

ST 060 112 1360
mm [inches]



Diagrama de flujo



Certificado

WRAS_2011026.

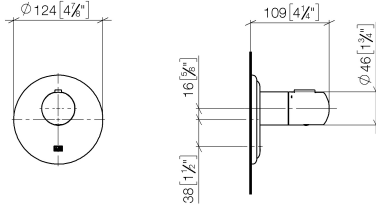
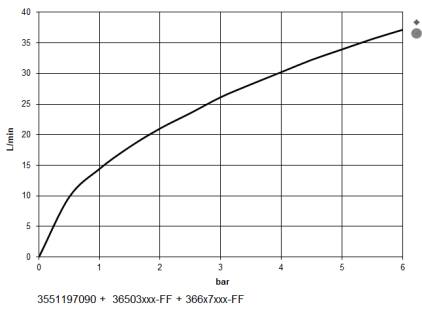
DVGW_DW-6512DN0706.

LGA_29930.

LGA_29932.

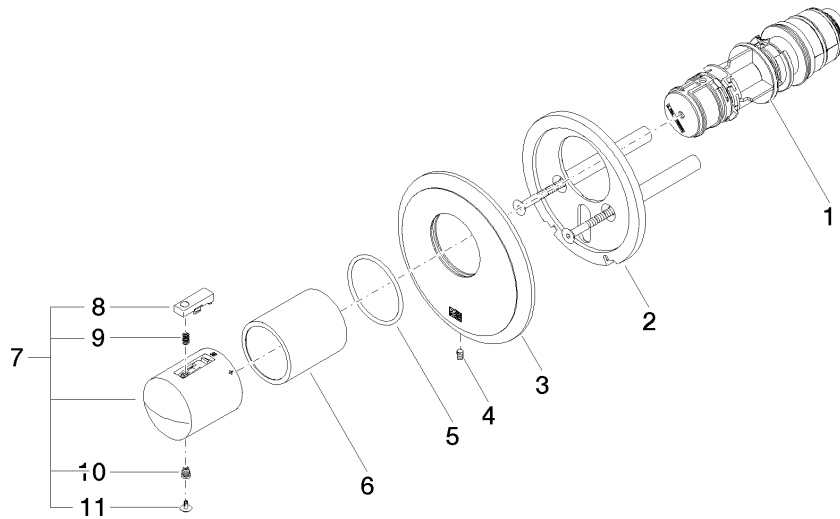

Lista de piezas de recambios

Nº	Número de artículo	Denominación	Cantidad de montaje	Plazo de entrega
1	90 15 02 063 00 90	cartucho	1	2
2	90 11 01 196 00 90	alojamiento	1	2
3	09 11 02 543-99	cobertura	1	30
4	09 31 11 048 90	varilla	1	2
5	90 14 10 049 00 90	sello	1	2
6	90 21 02 112 00-99	camisa	1	-
Ya no se puede pedir el repuesto, solicite el artículo de repuesto.				
7	90 17 33 005 01-99	manilla	1	30
8	90 21 33 011 00-13	manilla	1	2
9	90 16 02 027 00 90	resorte	1	2
10	90 30 30 136 00 90	tornillo	1	2
11	90 31 20 049 00-13	tapón	1	30







MADISON xTOOL Módulo termostático con tres llaves de paso - Dark Platinum cepillado

MADISON

ST 060 112 1360



- Roseta Ø 55 mm
- Montura con husillo ajustable y camisa
- 3x Plaquetas de porcelana HOT, COLD y NEUTRAL

	Dark Platinum cepillado	36 607 361-99
	Cromo	36 607 361-00
	Platino cepillado	36 607 361-06
	Platino	36 607 361-08
	Latón (Oro 23k)	36 607 361-09
	Latón cepillado (Oro 23k)	36 607 361-28

Complementos necesarios



- Válvula empotrada 1/2" -** 35 607 970 90
- Profundidad de montaje mín. 75 mm
 - Profundidad de montaje máx. 145 mm



MADISON xTOOL Módulo termostático con tres llaves de paso - Dark Platinum
cepillado

MADISON

ST 060 112 1360

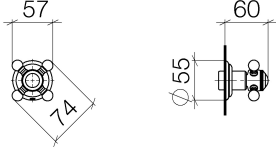

Certificado

DVGW_DW-
6501DN0116.

WRAS_2011026.

IAPMO_4976 (1).

LGA_29931.

WRAS_2010066.

DVGW_DW-
6512DN0706.

LGA_29932.

ST 060 112 1360

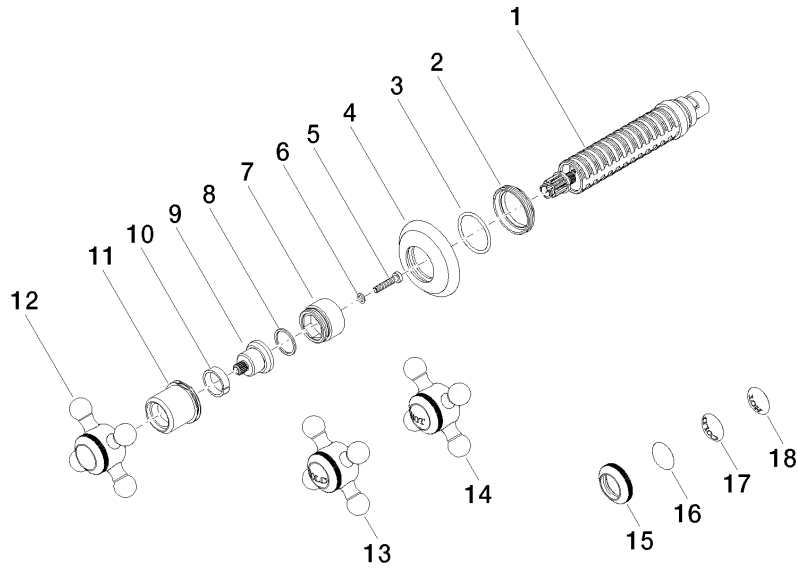

Lista de piezas de recambios

N°	Número de artículo	Denominación	Cantidad de montaje	Plazo de entrega
1	90 90 03 143 00 90	parte superior	1	2
2	09 23 10 125-00	tuerca	1	10
3	90 14 10 063 00 90	sello	1	2
4	09 27 36 102-99	roseta	1	30
5	90 30 30 075 00 90	tornillo	1	2
6	09 30 11 194 90	disco	1	2
7	09 18 30 007-99	camisa	1	60
8	90 28 10 030 00 90	anillo	1	2
9	09 12 12 064-99	alojamiento	1	-
Ya no se puede pedir el repuesto, solicite el artículo de repuesto.				
10	90 14 15 021 00 90	anillo	1	2
11	09 21 02 161-99	funda	1	30
12	04 20 36 100 02-99	manilla	1	30
13	04 20 36 100 00-99	manilla (cold)	1	30
14	04 20 36 100 01-99	manilla (hot)	1	30
15	09 20 36 005-99	manilla	1	30
16	09 26 01 016 90	accessorio	1	2
17	09 26 01 010 90	accessorio	1	2
18	09 26 01 011 90	accessorio	1	2