

ST 060 113 7811



- Cubierta 120 x 120 mm
- Maneta Ø 60mm
- Maneta acanalada con tope de seguridad en 38°C
- Cartucho termostático
- 2x Montura con husillo ajustable y camisa

Componentes individuales de este set

Necesita los siguientes componentes para este set

	2x	11 187 811-00		1x	36 416 780-00
	2x	36 310 811-00			



CYO xTOOL Módulo termostático con dos llaves de paso 1/2" - Cromo







CYO

ST 060 113 7811

ST 060 113 7811

- Sin distintivo



	Cromo	11 187 811-00
	Platino cepillado	11 187 811-06
	Platino	11 187 811-08
	Latón (Oro 23k)	11 187 811-09
	Dark Chrome	11 187 811-19
	Latón cepillado (Oro 23k)	11 187 811-28
	Dark Platinum cepillado	11 187 811-99

ST 060 113 7811

mm [inches]

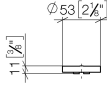

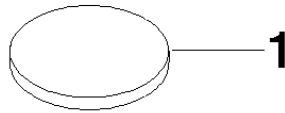

ST 060 113 7811

Piezas para otros acabados pueden encontrarse aquí:
Platino cepillado



- Cubierta 120 x 120 mm
- Maneta acanalada con tope de seguridad en 38°C

	Cromo	36 416 780-00
	Cromo cepillado	36 416 780-93

Encaja con: MEM, CL.1



CYO xTOOL Módulo termostático con dos llaves de paso 1/2" - Cromo

CYO

ST 060 113 7811

ST 060 113 7811



Diagrama de flujo



Certificado

IAPMO_4976 (5).

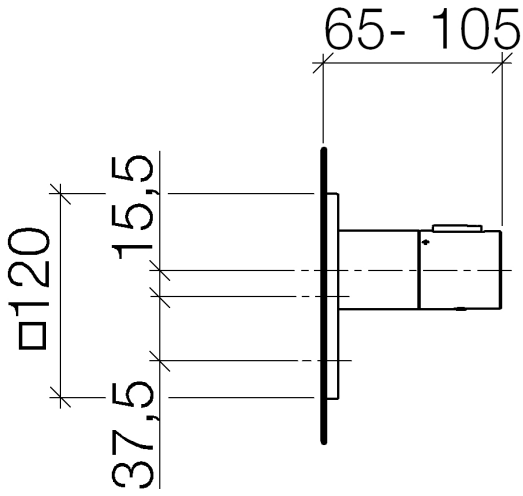
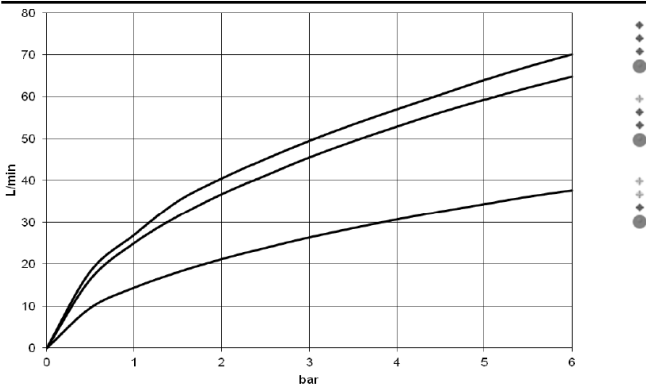
ST 060 113 7811

Piezas para otros acabados pueden encontrarse aquí:
Cromo cepillado

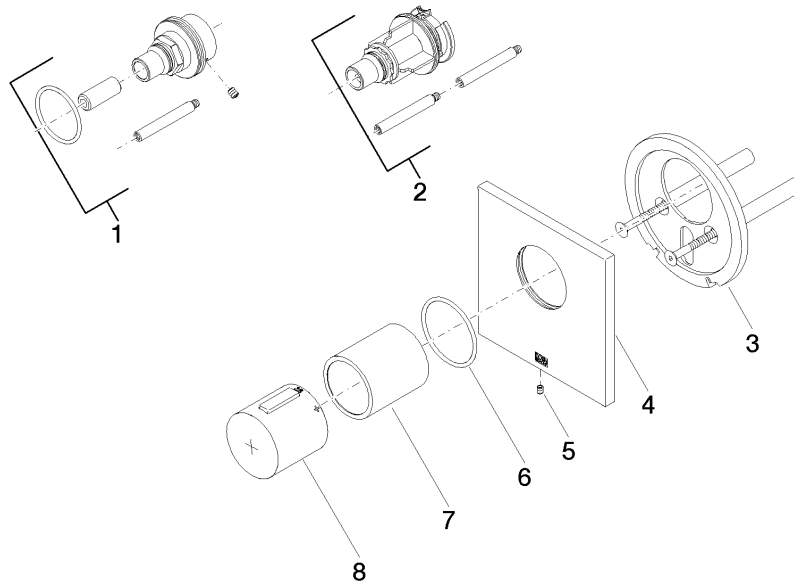

Lista de piezas de recambios

N°	Número de artículo	Denominación	Cantidad de montaje	Plazo de entrega
1	12 177 970 90	Prolongación 28 mm -	1	2
2	12 178 970 90	Prolongación 46 mm -	1	2
3	90 11 01 196 00 90	alojamiento	1	2
4	90 11 02 533 00-00	cobertura	1	10
5	09 31 11 044 90	varilla	1	2
6	90 14 10 049 00 90	sello	1	2
7	90 21 02 112 00-00	camisa	1	10
8	90 17 33 017 00-00	manilla	1	10

ST 060 113 7811



- Sin roseta
- Maneta Ø 60mm
- Montura con husillo ajustable y camisa

ATENCIÓN: ¡Los elementos de manilla deben solicitarse independientemente de las griferías!





CYO xTOOL Módulo termostático con dos llaves de paso 1/2" - Cromo

CYO

ST 060 113 7811

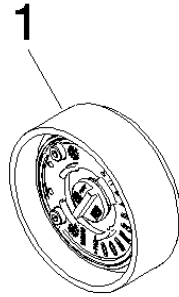

Lista de piezas de recambios

N°	Número de artículo	Denominación	Cantidad de montaje	Plazo de entrega
1	90 18 40 291 01-00	manilla	1	10