

**Flush plate for concealed WC cisterns made by Geberit angular - Durabrass (23kt Gold)**

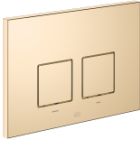









MEM

12 665 980



- cover plate 169 x 246 x 12 mm
- Mechanical flush plate with manual flush buttons
- For 2-volume flushing system
- Includes mounting frame, actuator rods and fastening material
- Sound-absorbing push rods, tool-free fast adjustment
- Compatible with all Geberit Sigma series cisterns from 2001 onwards

Fits: MEM, CL.1

	Durabrass (23kt Gold)	12 665 980-09
	Chrome	12 665 980-00
	Brushed Platinum	12 665 980-06
	Platinum	12 665 980-08
	Dark Chrome	12 665 980-19
	Light Gold	12 665 980-26
	Brushed Light Gold	12 665 980-27
	Brushed Durabrass (23kt Gold)	12 665 980-28
	Matte Black	12 665 980-33
	Brushed Bronze	12 665 980-42
	Brushed Champagne (22kt Gold)	12 665 980-46
	Champagne (22kt Gold)	12 665 980-47
	Brushed Chrome	12 665 980-93
	Brushed Dark Platinum	12 665 980-99

Flush plate for concealed WC cisterns made by Geberit angular - Durabronze  
(23kt Gold)

MEM

12 665 980  
mm [inches]



Flush plate for concealed WC cisterns made by Geberit angular - Durabrass  
(23kt Gold)

MEM

12 665 980  
Parts for other  
finishes can be found  
here: [Chrome](#)

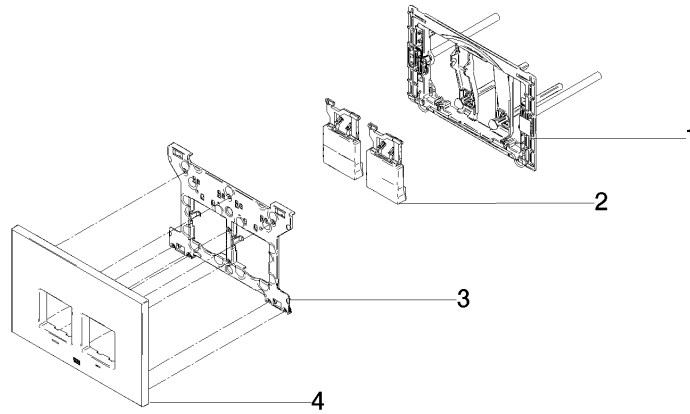

Spare parts list

No.	Item Number	Name	Quantity used	Delivery time
1	90 28 01 030 00 90	base	1	2
2	90 20 98 000 00-09	button	2	40
3	90 28 10 212 00 90	base	2	2
4	90 11 98 012 00-09	cover	4	-

Spare part can no longer be ordered, please order the replacement item