







CL.1 Deck valve clockwise closing cold - Brushed Platinum

CL.1

20 006 705 Product version from 3/9/2015



- with CASCADE structure
- hole diameter 32 mm
- rosette 60 x 47 mm
- with cold marking
- WRAS

	Brushed Platinum	20 006 705-06
	Chrome	20 006 705-00
	Dark Chrome	20 006 705-19
	Brushed Champagne (22kt Gold)	20 006 705-46
	Champagne (22kt Gold)	20 006 705-47
	Brushed Dark Platinum	20 006 705-99

20 006 705 Product version from 3/9/2015

mm [inches]

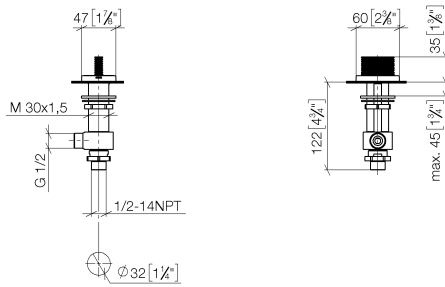

Flow rate chart



Codes & Standards

ASME A112.18.1	cUPC	DIN 4109	ISO 3822
NSF372	NSF61	Scottish Water Byelaws	UK Water Supply Regulations

Ü-Zeichen



CL.1 Deck valve clockwise closing cold - Brushed Platinum

CL.1

20 006 705 Product version from 3/9/2015

Certificates and sustainability

WRAS_1804

IAPMO_N-4

LGA_28

IAPMO_4976

IAPMO_6

WRAS_240202

20 006 705 Product version from 3/9/2015

Parts for other finishes can be found here: [Chrome](#)

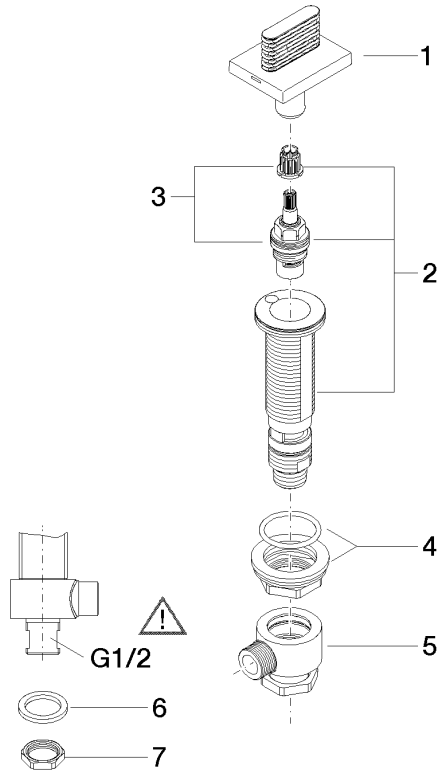

Spare parts list

No.	Item Number	Name	Quantity used	Delivery time
4	04 23 10 032 78 90	fixing set	1.00	2
7	09 30 11 059 90	disc	1.00	2
5	04 17 11 023 10 90	distributor	1.00	2
3	90 90 03 153 00 90	top	1.00	2
2	04 17 11 058 53 90	side panel	1.00	2
1	90 20 70 053 06-06	handle (cold)	1.00	10
8	09 23 10 012 90	nut	1.00	2
6	90 23 30 040 00-06	threaded connector	1.00	10