

**IMO Three-hole single-lever bath mixer for bath rim or tile edge installation -
Dark Chrome**







IMO

27 412 670



- 224mm projection
- spout: cascade
- max. flow 19.2 l/min at 3 bar flow pressure
- Hand shower: COMPACT RAIN, max. flow rate 6.8 l/min (at 3 bar)
- complete hand shower set with anti-scale system
- automatic bath/shower diverter
- height of mixer 110 mm
- height up to aerator 138 mm
- hole diameter spout 32 mm
- single-lever mixer hole diameter 35 mm
- hole diameter for complete hand shower set 32 mm
- rosette for mixer 60 x 60mm
- rosette for spout 60 x 60mm
- rosette for complete hand shower set 60 x 60mm
- metal shower hose 2250mm with integrated anti-twist protection

Intrinsic protection against back flow.

	Dark Chrome	27 412 670-19
	Chrome	27 412 670-00
	Brushed Platinum	27 412 670-06
	Brushed Light Gold	27 412 670-27
	Matte Black	27 412 670-33
	Brushed Chrome	27 412 670-93

Recommended miscellaneous



Perfecto installation kit - 12 614 970 90

Recommended miscellaneous



**Decorative caps for Perfecto -
Dark Chrome** 12 801 970-19
• 1 pair

27 412 670
mm [inches]

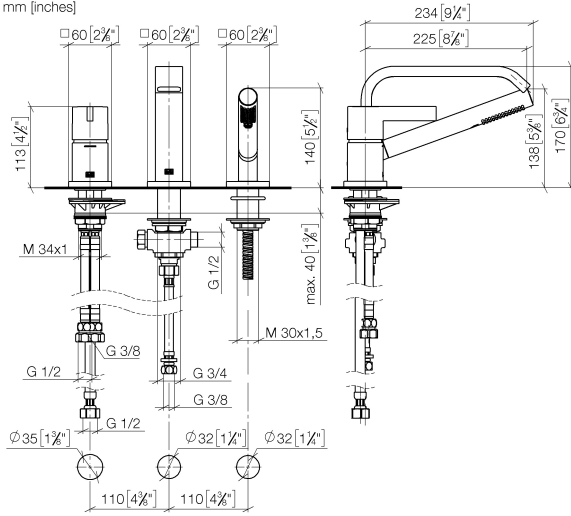

Flow rate chart

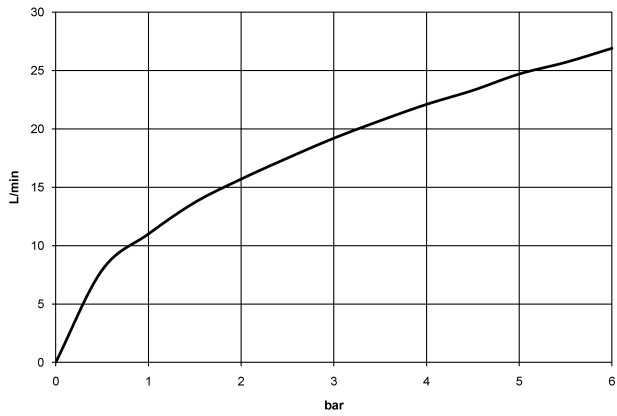

Certificates

Belgaqua_24-008-
27_4.

IMO Three-hole single-lever bath mixer for bath rim or tile edge installation -
Dark Chrome

IMO

27 412 670

