

Rain shower with wall fixing 400 mm - Brushed Chrome

TARA













28 659 970



- 450mm projection
- rain shower Ø 400 mm
- PURE RAIN, max. flow rate 20 l/min (at 3 bar)
- Function from: 12 l/min
- rosette Ø 60 mm
- 1/2" connection
- with anti-scale system
- WRAS 1707033

Product change as of 1st April 2024: max. flow 20l/min

Fits: TARA, LISSÉ, VAIA, META

	Brushed Chrome	28 659 970-93
	Chrome	28 659 970-00
	Brushed Platinum	28 659 970-06
	Platinum	28 659 970-08
	Dark Chrome	28 659 970-19
	Light Gold	28 659 970-26
	Brushed Light Gold	28 659 970-27
	Brushed Durabronze (23kt Gold)	28 659 970-28
	Matte Black	28 659 970-33
	Brushed Bronze	28 659 970-42
	Brushed Champagne (22kt Gold)	28 659 970-46
	Champagne (22kt Gold)	28 659 970-47
	Brushed Dark Platinum	28 659 970-99

Recommended miscellaneous

- Concealed wall elbow -** 35 085 970 90
- max. recess depth 163 mm
 - min. recess depth 90 mm



28 659 970

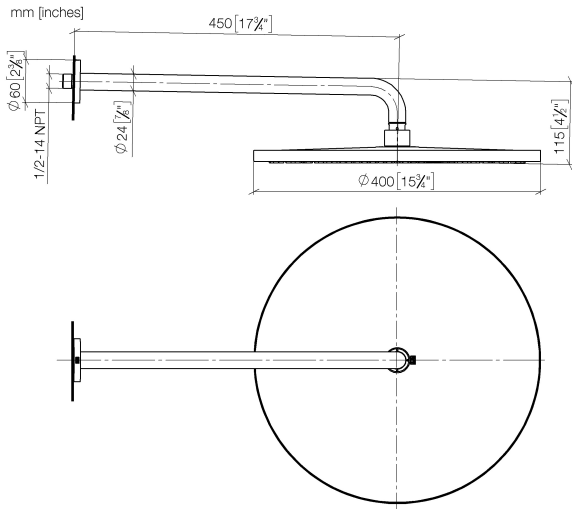

Flow rate chart

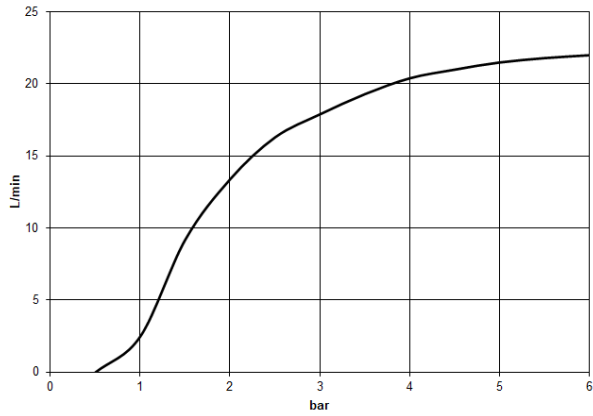

Certificates

LGA_29237.

LGA_29238.

WRAS_2212012.

DVGW_DW-6517DN0118.

28 659 970

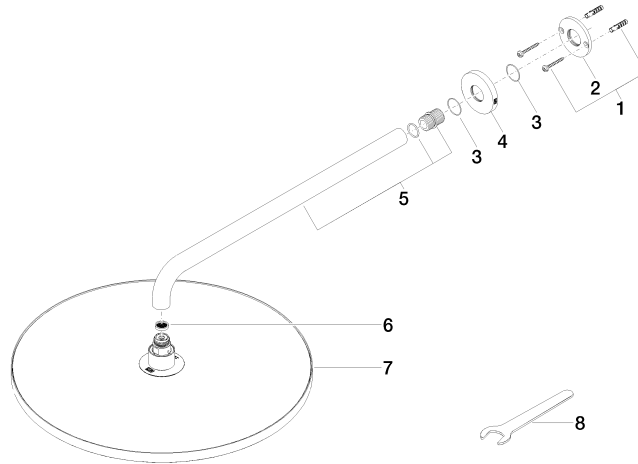

Spare parts list

No.	Item Number	Name	Quantity used	Delivery time
1	04 30 31 032 00 90	fixing set	1	2
2	09 17 20 120 90	holder	1	2
3	09 14 10 150 90	seal	2	2
4	09 27 97 015-93	rosette	1	20
5	90 11 03 070 00-93	pipe	1	20
6	09 23 01 075 90	insert	1	2
7	04 12 05 090 00-93	shower	1	20
8	90 30 09 069 00 90	key	1	2