











**META Wall-mounted valve cold water without pop-up waste - Brushed  
Champagne (22kt Gold)**

META

30 010 662



- 126mm projection
- fixed spout
- circular, air-enriched flow
- hole diameter 35 mm
- rosette Ø 60 mm
- max. flow 5.7 l/min
- lead-free
- This product can help a building meet the requirements of Green Building Rating Systems, e.g. LEED®, BREEAM®, DGNB

	Brushed Champagne (22kt Gold)	30 010 662-46
	Chrome	30 010 662-00
	Brushed Platinum	30 010 662-06
	Dark Chrome	30 010 662-19
	Light Gold	30 010 662-26
	Brushed Light Gold	30 010 662-27
	Matte Black	30 010 662-33
	Brushed Bronze	30 010 662-42
	Champagne (22kt Gold)	30 010 662-47
	Brushed Chrome	30 010 662-93
	Brushed Dark Platinum	30 010 662-99

30 010 662  
mm [inches]

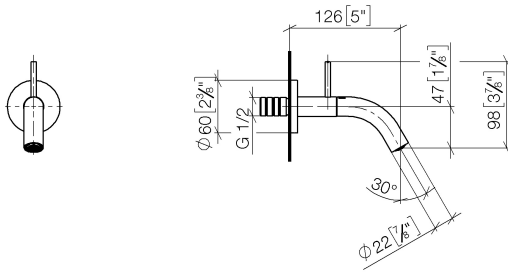

**Flow rate chart**



**Certificates**

LGA\_38414.

30 010 662  
Parts for other  
finishes can be found  
here: [Chrome](#)

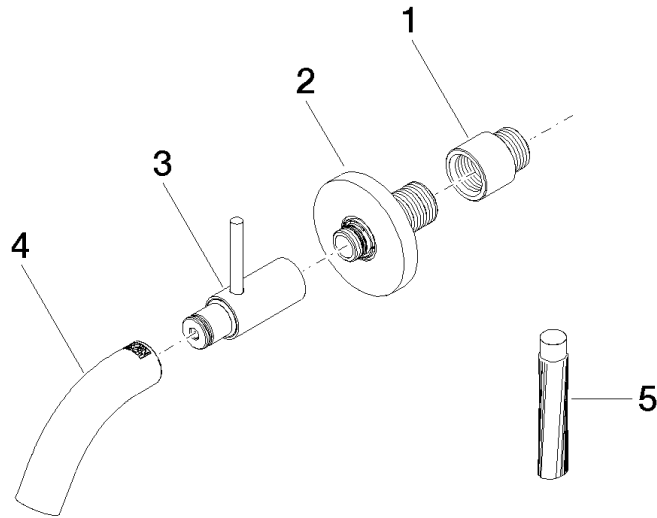

**Spare parts list**

No.	Item Number	Name	Quantity used	Delivery time
1	09 24 03 072 10 90	nipple	1	2
2	90 27 66 019 00-46	rosette	1	30
3	90 20 66 023 00-46	handle	1	30
4	90 28 22 385 00-46	spout	1	30
5	09 16 03 001 90	grease	1	2