















33 501 662



- 125mm projection
- fixed spout
- circular, air-enriched flow
- height of mixer 134 mm
- height up to aerator 52 mm
- hole diameter 35 mm
- 2x screw-in M 8 x 1 pressure hose, leak-tested
- max. flow 5.7 l/min
- lead-free
- This product can help a building meet the requirements of Green Building Rating Systems, e.g. LEED®, BREEAM®, DGNB
- WRAS 2003051

Only suitable for basins with an overflow.

| | | |
|--|--------------------------------|---------------|
|  | Light Gold | 33 501 662-26 |
|  | Chrome | 33 501 662-00 |
|  | Brushed Platinum | 33 501 662-06 |
|  | Platinum | 33 501 662-08 |
|  | Dark Chrome | 33 501 662-19 |
|  | Brushed Light Gold | 33 501 662-27 |
|  | Brushed Durabronze (23kt Gold) | 33 501 662-28 |
|  | Red | 33 501 662-29 |
|  | Orange | 33 501 662-30 |
|  | Dark Green | 33 501 662-31 |
|  | Matte Black | 33 501 662-33 |
|  | Brushed Bronze | 33 501 662-42 |
|  | Brushed Champagne (22kt Gold) | 33 501 662-46 |
|  | Champagne (22kt Gold) | 33 501 662-47 |
|  | Brushed Chrome | 33 501 662-93 |
|  | Brushed Dark Platinum | 33 501 662-99 |

33 501 662

mm [inches]

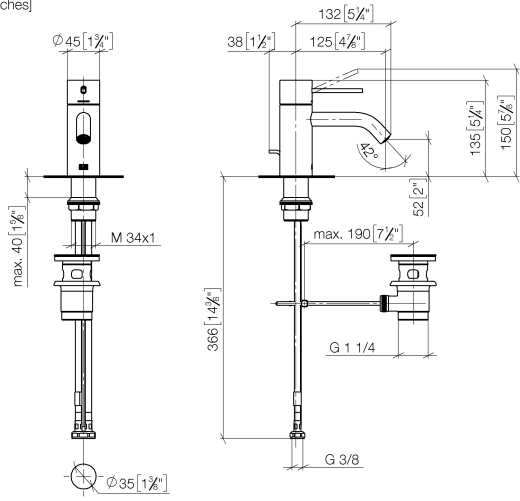

Flow rate chart



33 501 662

Product version from 10/1/2021

Parts for other finishes can be found here: [Chrome](#)

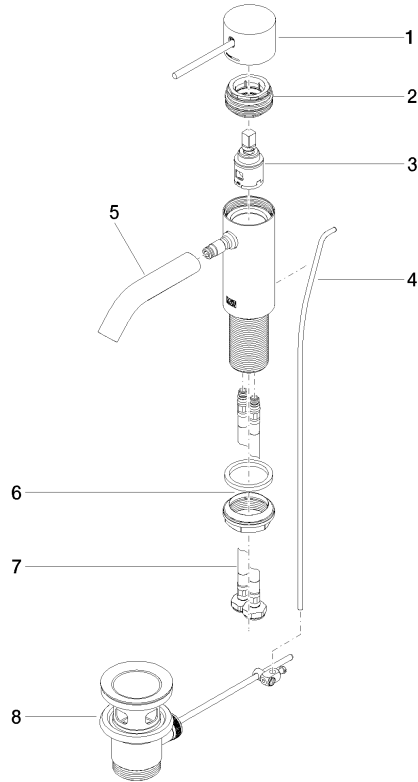



33 501 662

Spare parts list

Product version from 10/1/2021