

IMO Single-lever basin mixer with raised base without pop-up waste - Brushed Light Gold







IMO

33 537 671



- 170mm projection
- fixed spout
- rectangular, air-enriched flow
- height of mixer 298 mm
- height up to aerator 230 mm
- hole diameter 35 mm
- 2x screw-in M 10 x 1 pressure hose, leak-tested
- max. flow 4.6 l/min
- lead-free
- This product can help a building meet the requirements of Green Building Rating Systems, e.g. LEED®, BREEAM®, DGNB

for use on countertop bowls

| | | |
|---|-----------------------|---------------|
|  | Brushed Light Gold | 33 537 671-27 |
|  | Chrome | 33 537 671-00 |
|  | Brushed Platinum | 33 537 671-06 |
|  | Dark Chrome | 33 537 671-19 |
|  | Matte Black | 33 537 671-33 |
|  | Brushed Chrome | 33 537 671-93 |
|  | Brushed Dark Platinum | 33 537 671-99 |

33 537 671
mm [inches]

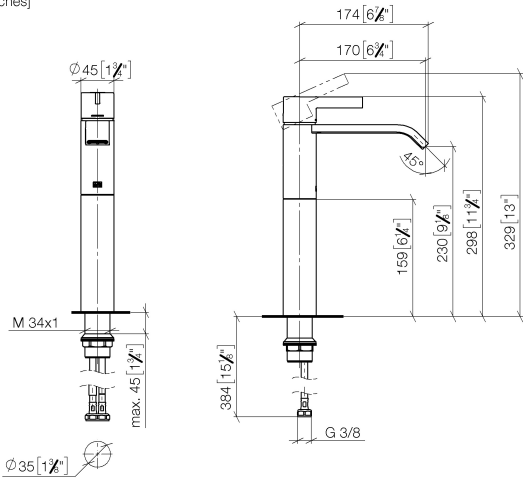

Flow rate chart

