

33 815 888



- 236mm projection
- pivotable spout 360°
- air-enriched flow
- height of mixer 400 mm
- height up to aerator 230 mm
- hole diameter 35 mm
- max. flow 7 l/min at 3 bar flow pressure
- lead-free
- WRAS 2311044
- This product can help a building meet the requirements of Green Building Rating Systems, e.g. LEED®, BREEAM®, DGNB

	Brushed Chrome	33 815 888-93
	Chrome	33 815 888-00
	Brushed Platinum	33 815 888-06
	Platinum	33 815 888-08
	Durabronze (23kt Gold)	33 815 888-09
	Dark Chrome	33 815 888-19
	Brushed Durabronze (23kt Gold)	33 815 888-28
	Matte Black	33 815 888-33
	Brushed Champagne (22kt Gold)	33 815 888-46
	Champagne (22kt Gold)	33 815 888-47
	Brushed Dark Platinum	33 815 888-99

Recommended miscellaneous

Strainer waste with control handle - Brushed Chrome 10 710 970-93



Recommended miscellaneous

Dispenser with rosette - Brushed Chrome 82 444 970-93



33 815 888

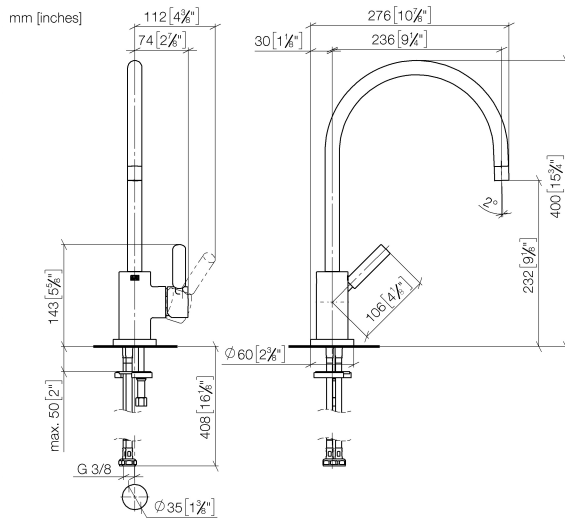

Flow rate chart



Certificates

GDV_0400195.

WRAS_2311044.

33 815 888

Parts for other finishes can be found here: [Chrome](#)



Spare parts list

No.	Item Number	Name	Quantity used	Delivery time
1	90 28 22 049 02-93	spout	1	20
2	90 23 01 028 03-93	aerator	1	20
3	09 30 30 054 90	screw	1	2
4	90 15 05 065 00 90	cartridge	1	2
5	90 28 10 148 00 90	accessories	1	2
6	09 24 04 107-93	nut	1	20
7	90 20 88 040 00-93	handle	1	20
8	09 31 11 010 90	pin	1	2
9	90 24 04 048 00-93	nipple	1	20
10	11 170 880-93	handle	1	60
11	04 30 04 104 00 90	hose	2	2
12	09 28 10 055-93	rosette	1	60
13	09 14 10 034 90	seal	1	2
14	04 30 11 038 00 90	fixing set	1	2
15	09 31 11 011 90	pin	1	2
16	12 803 970 90	extension	1	60