

Shower thermostat for wall mounting - Brushed Dark Platinum

IMO













34 442 979



- slide-on rosettes Ø 70 mm
- gauge 150 mm - 13 mm
- 3/8" shower outlet
- with volume control
- WRAS 2204005

Intrinsic protection against back flow.

Fits: IMO, LULU, MEM, TARA, LISSÉ, VAIA, META

| | | |
|---|--------------------------------|---------------|
|  | Brushed Dark Platinum | 34 442 979-99 |
|  | Chrome | 34 442 979-00 |
|  | Brushed Platinum | 34 442 979-06 |
|  | Platinum | 34 442 979-08 |
|  | Dark Chrome | 34 442 979-19 |
|  | Light Gold | 34 442 979-26 |
|  | Brushed Light Gold | 34 442 979-27 |
|  | Brushed Durabronze (23kt Gold) | 34 442 979-28 |
|  | Matte Black | 34 442 979-33 |
|  | Brushed Bronze | 34 442 979-42 |
|  | Brushed Champagne (22kt Gold) | 34 442 979-46 |
|  | Champagne (22kt Gold) | 34 442 979-47 |
|  | Brushed Chrome | 34 442 979-93 |

34 442 979

mm [inches]

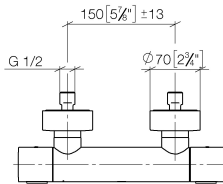
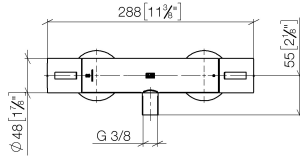

Flow rate chart

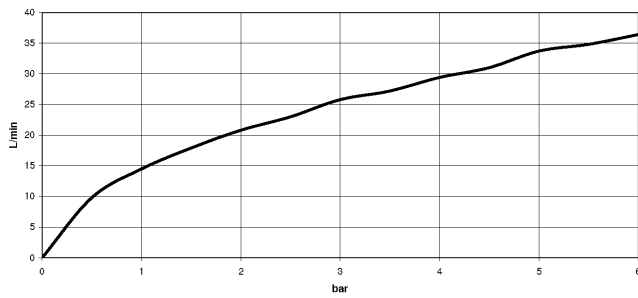

Certificates

DVGW_DW-
6509DN0123.

LGA_29986.

WRAS_2204005.

Belgaqua_21-032-
27_5.

34 442 979

Parts for other finishes can be found here: [Chrome](#)

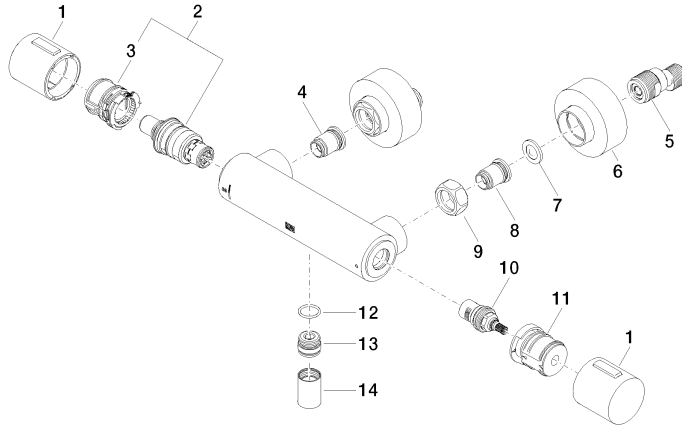

Spare parts list

| No. | Item Number | Name | Quantity used | Delivery time |
|-----|--------------------|------------|---------------|---------------|
| 1 | 90 17 33 015 00-99 | handle | 2 | 30 |
| 2 | 90 15 02 070 00 90 | cartridge | 1 | 2 |
| 3 | 90 30 40 010 00 90 | regulator | 1 | 2 |
| 4 | 04 31 20 530 00 90 | insert | 1 | 2 |
| 5 | 04 11 04 030 00 90 | connection | 2 | 2 |
| 6 | 90 31 20 512 00-99 | rosette | 2 | 30 |
| 7 | 09 29 30 050 90 | sieve | 2 | 2 |
| 8 | 04 31 20 540 00 90 | insert | 1 | 2 |
| 9 | 09 24 77 008-00 | nut | 2 | 10 |
| 10 | 90 90 03 236 00 90 | top | 1 | 2 |
| 11 | 90 30 40 017 00 90 | base | 1 | 2 |
| 12 | 90 14 10 010 00 90 | seal | 1 | 2 |
| 13 | 09 31 20 511-99 | nipple | 1 | 60 |
| 14 | 90 21 02 069 00-99 | cover | 1 | 30 |