

## Showerpipe with shower thermostat without hand shower FlowReduce - Chrome

IMO

34 459 979















Fits: IMO, LULU, TARA, LISSÉ, VAIA, META

- shower with fixed riser projection 453mm
- overhead shower: rain flow
- rain shower Ø 220 mm
- rain shower with anti-scale system
- max. rainshower flow 7 l/min
- rotary diverter with volume control and shut-off function
- slide-on rosettes Ø 70 mm
- height of fittings up to rain shower (bottom edge) 1009mm
- height of fittings up to top edge of elbow 1150mm
- gauge 150 mm - 13 mm
- metal shower hose 1750mm with integrated anti-twist protection
- 1/2" connection
- slide bar
- Pipe diameter 23.5 mm
- quick clearing
- This product can help a building meet the requirements of Green Building Rating Systems, e.g. LEED®, BREEAM®, DGNB
- WRAS 2204013

This article does not include a hand shower!

Intrinsic protection against back flow.

	Chrome	34 459 979-00
	Brushed Platinum	34 459 979-06
	Platinum	34 459 979-08
	Dark Chrome	34 459 979-19
	Light Gold	34 459 979-26
	Brushed Light Gold	34 459 979-27
	Brushed Durabronze (23kt Gold)	34 459 979-28
	Matte Black	34 459 979-33
	Brushed Bronze	34 459 979-42
	Brushed Champagne (22kt Gold)	34 459 979-46
	Champagne (22kt Gold)	34 459 979-47
	Brushed Chrome	34 459 979-93
	Brushed Dark Platinum	34 459 979-99

Showerpipe with shower thermostat without hand shower FlowReduce -  
Chrome

IMO

34 459 979

Required miscellaneous

	<b>Hand shower - Chrome</b>	28 016 979-00
---	-----------------------------	---------------

Required miscellaneous

	<b>Hand shower FlowReduce - Chrome</b>	28 016 979-00 0010
---	--	-----------------------

Required miscellaneous

	<b>Hand shower - Chrome</b>	28 017 979-00
---	-----------------------------	---------------

Required miscellaneous

	<b>Hand shower FlowReduce - Chrome</b>	28 018 979-00 0010
---	--	-----------------------

Required miscellaneous

	<b>SERIES-VARIOUS Hand shower - Chrome</b>	28 027 979-00 0010
---	--	-----------------------

Required miscellaneous

	<b>SERIES-VARIOUS Hand shower - Chrome</b>	28 025 979-00 0010
---	--	-----------------------

Required miscellaneous

	<b>Hand shower - Chrome</b>	28 012 979-00
---	-----------------------------	---------------

Required miscellaneous

	<b>Hand shower FlowReduce - Chrome</b>	28 012 979-00 0010
---	--	-----------------------

Required miscellaneous

	<b>Hand shower - Chrome</b>	28 018 979-00
---	-----------------------------	---------------

Required miscellaneous

	<b>SERIES-VARIOUS Hand shower - Chrome</b>	28 029 979-00
---	--	---------------

Required miscellaneous

	<b>SERIES-VARIOUS Hand shower - Chrome</b>	28 029 979-00 0010
---	--	-----------------------

34 459 979  
mm [inches]  
1:10

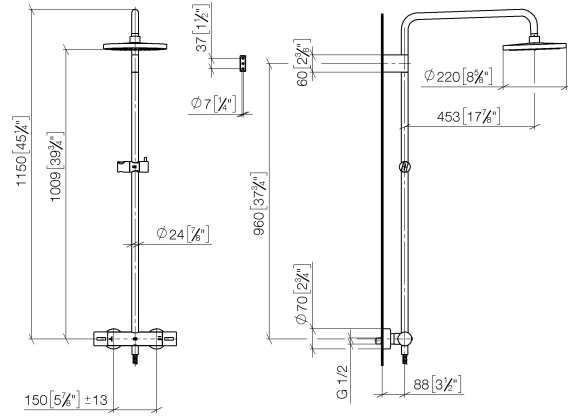

Flow rate chart

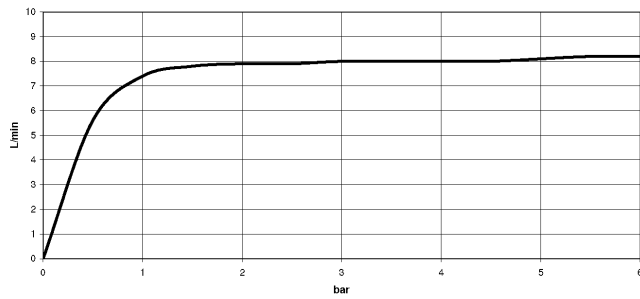

Certificates

DVGW\_DW-6509DN0123.      Belgaqua\_21-032-27\_5.      WRAS\_2204013.      LGA\_38737.

34 459 979

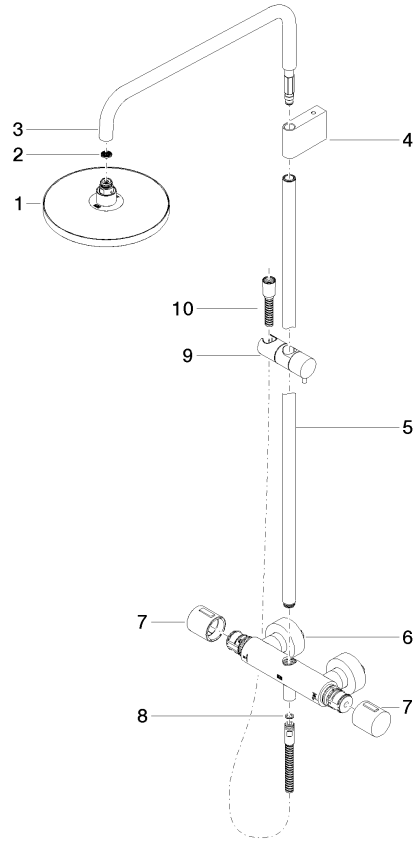

### Spare parts list

No.	Item Number	Name	Quantity used	Delivery time
1	90 12 05 092 20-00	shower	1	10
2	09 23 01 039 90	sieve	1	2
3	90 28 22 348 00-00	pipe	1	10
4	90 17 11 150 00-00	holder	1	10
5	90 28 22 349 00-00	pipe	1	10
6	04 17 01 250 00-00	connection	1	10
7	90 17 33 015 00-00	handle	2	10
8	90 14 20 026 00 90	seal	1	2
9	12 570 970-00	Slide unit - Chrome	1	10
10	28 322 970-00	Metal shower hose 1/2" x 3/8" x 1750 mm - Chrome	1	2