

## WATER CURVE Concealed body spray - Chrome













IMO

36 514 979



- AQUAPRESSURE FLOW, max. flow rate 10 l/min (at 3 bar)
- water jet adjustable
- cover plate 120 x 60 mm
- 1/2" connection
- WRAS 2005004

Fits: IMO, LULU, MADISON, MEM, TARA, CL.1, LISSÉ, VAIA, META, CYO

	Chrome	36 514 979-00
	Brushed Platinum	36 514 979-06
	Platinum	36 514 979-08
	Dark Chrome	36 514 979-19
	Light Gold	36 514 979-26
	Brushed Light Gold	36 514 979-27
	Brushed Durabronze (23kt Gold)	36 514 979-28
	Matte Black	36 514 979-33
	Brushed Bronze	36 514 979-42
	Brushed Champagne (22kt Gold)	36 514 979-46
	Champagne (22kt Gold)	36 514 979-47
	Brushed Chrome	36 514 979-93
	Brushed Dark Platinum	36 514 979-99

### Recommended miscellaneous

- |   |                               |               |
|---|-------------------------------|---------------|
|  | <b>Concealed wall elbow -</b> | 35 085 970 90 |
|   | • max. recess depth 163 mm    |               |
|   | • min. recess depth 90 mm     |               |

36 514 979

mm [inches]

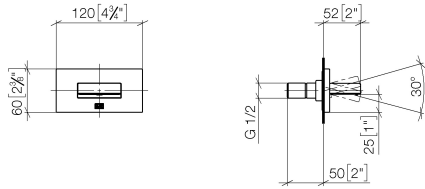

**Flow rate chart**

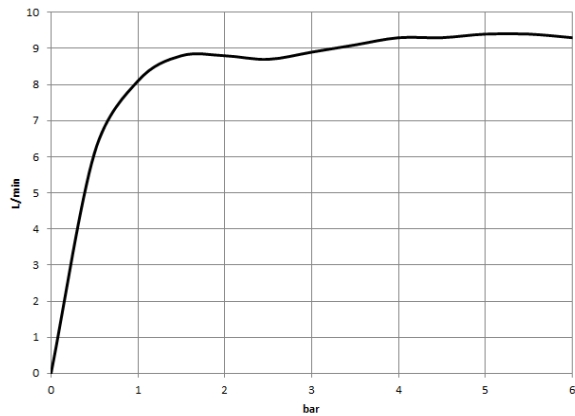

**Trajectory diagram**

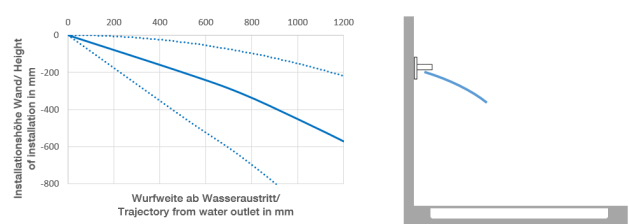

**Certificates**

WRAS\_2005004. LGA\_29336.

36 514 979

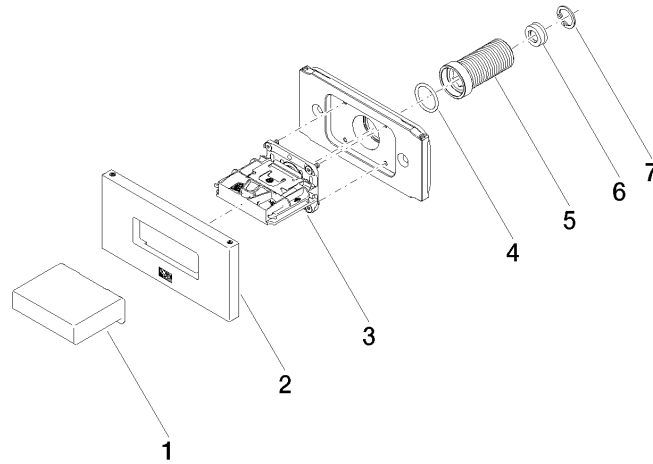

**Spare parts list**

No.	Item Number	Name	Quantity used	Delivery time
1	09 17 01 230-00	casing	1	10
2	90 27 97 041 00-00	rosette	1	10
3	90 29 03 088 00 90	insert	1	2
4	90 14 10 010 00 90	seal	1	2
5	09 24 04 336 90	nipple	1	2
6	09 23 01 134 90	flow reducer	1	2
7	09 16 01 014 90	ring	1	2