

WATER CURVE Concealed body spray - Champagne (22kt Gold)













IMO

36 514 979



- AQUAPRESSURE FLOW, max. flow rate 10 l/min (at 3 bar)
- water jet adjustable
- cover plate 120 x 60 mm
- 1/2" connection
- WRAS 2005004

Fits: IMO, LULU, MADISON, MEM, TARA, CL.1, LISSÉ, VAIA, META, CYO

| | | |
|---|--------------------------------|---------------|
|  | Champagne (22kt Gold) | 36 514 979-47 |
|  | Chrome | 36 514 979-00 |
|  | Brushed Platinum | 36 514 979-06 |
|  | Platinum | 36 514 979-08 |
|  | Dark Chrome | 36 514 979-19 |
|  | Light Gold | 36 514 979-26 |
|  | Brushed Light Gold | 36 514 979-27 |
|  | Brushed Durabronze (23kt Gold) | 36 514 979-28 |
|  | Matte Black | 36 514 979-33 |
|  | Brushed Bronze | 36 514 979-42 |
|  | Brushed Champagne (22kt Gold) | 36 514 979-46 |
|  | Brushed Chrome | 36 514 979-93 |
|  | Brushed Dark Platinum | 36 514 979-99 |

Recommended miscellaneous

- Concealed wall elbow -** 35 085 970 90
- max. recess depth 163 mm
 - min. recess depth 90 mm



36 514 979

mm [inches]

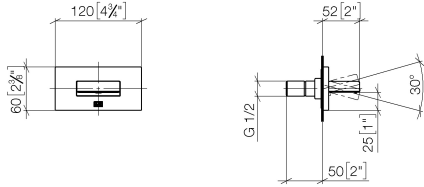

Flow rate chart



Trajectory diagram

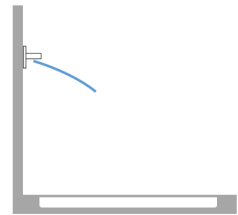
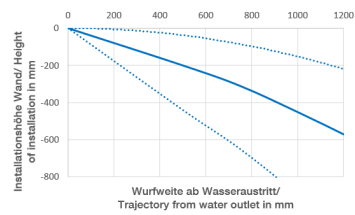

Certificates

LGA_29336.

36 514 979

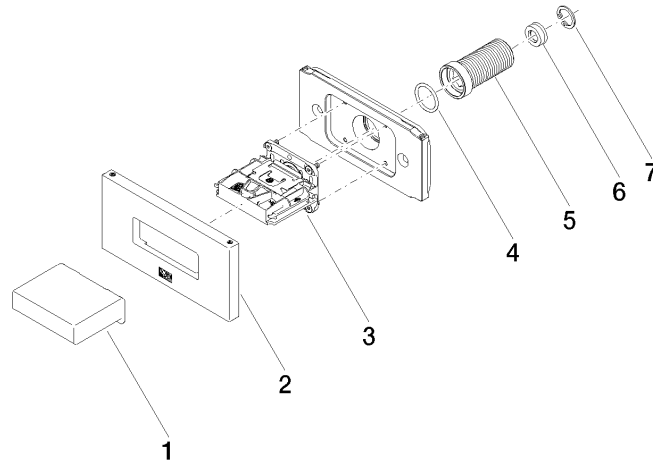

Spare parts list

| No. | Item Number | Name | Quantity used | Delivery time |
|-----|--------------------|--------------|---------------|---------------|
| 1 | 09 17 01 230-47 | casing | 1 | 30 |
| 2 | 90 27 97 041 00-47 | rosette | 1 | 30 |
| 3 | 90 29 03 088 00 90 | insert | 1 | 2 |
| 4 | 90 14 10 010 00 90 | seal | 1 | 2 |
| 5 | 09 24 04 336 90 | nipple | 1 | 2 |
| 6 | 09 23 01 134 90 | flow reducer | 1 | 2 |
| 7 | 09 16 01 014 90 | ring | 1 | 2 |