

Single sink - Stainless Steel

38 500 003



- under-mounted
- 500 x 400 mm
- sink depth 175 mm
- suitable for base units 550 mm
- radius 12 mm

Drain and overflow set not included in the scope of supply. See Required miscellaneous.

Drain and overflow set not included in the scope of supply. See Required miscellaneous.

Required miscellaneous



Pop-up waste and overflow with electronic control - Stainless Steel 10 410 003-85
 • 3½" electronic drain valve (TouchFlow)

Required miscellaneous



Pop-up waste and overflow closable by hand - Stainless Steel 10 400 003-85
 • 3½" drain valve closable by hand

Required miscellaneous



Pop-up waste and overflow with knob - Stainless Steel 10 405 003-85
 • 3½" strainer waste valve

Single sink - Stainless Steel

38 500 003

mm [inches]

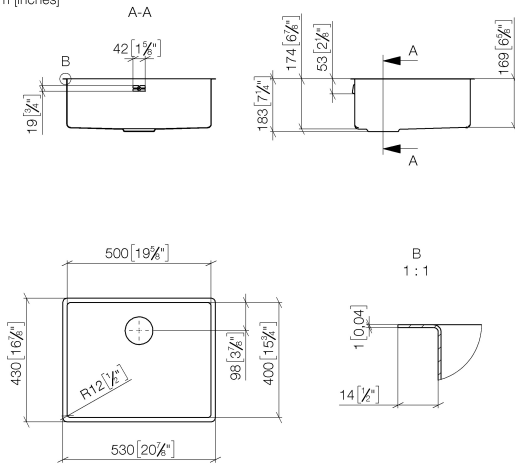

Single sink - Stainless Steel

38 500 003

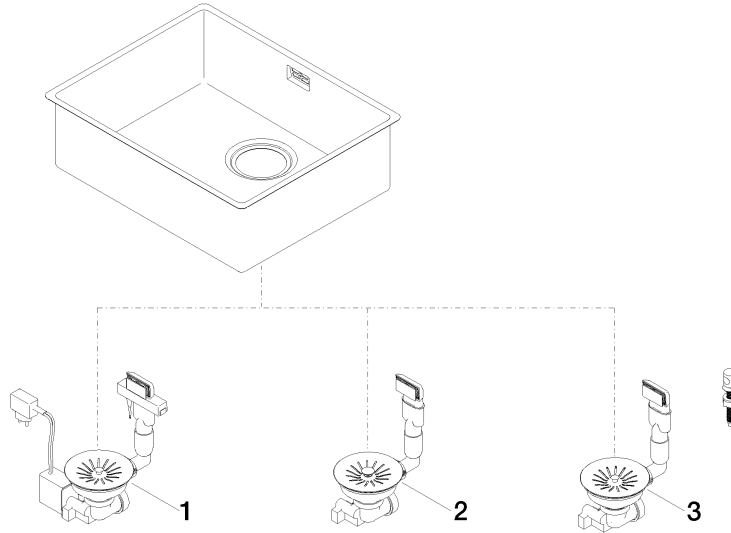

Spare parts list

No.	Item Number	Name	Quantity used	Delivery time
1	10 410 003-85	Pop-up waste and overflow with electronic control - Stainless Steel	1	2
2	10 400 003-85	Pop-up waste and overflow closable by hand - Stainless Steel	1	2
3	10 405 003-85	Pop-up waste and overflow with knob - Stainless Steel	1	2