

SERENITY SKY Rain panel for recessed ceiling installation with light - Chrome

41 771 979









- exposed trim parts
- Rain panel with 2 different spray modes
- PURIFY RAIN, 175 x 175 mm, max. flow rate 10 l/min (at 3 bar)
- FULL RAIN, 455 x 315 mm, max. flow rate 14 l/min (at 3 bar)
- Rain panel, 600 x 420 mm
- min. recess depth 150 mm
- weight 15kg
- feed pipe (hot/cold): 2x DN 20
- with anti-scale system
- Recommended control element: xTool

electrical:

- RGBW LED ambient lighting
- Electricity supply: 100-240 V AC, 50-60 Hz, 20 W
- system of protection: IP 65
- Feeder 3 x 1.5 mm² NYM-J
- equipotential bonding 1 x 4mm²
- earth-leakage circuit-breaker 30 mA provided
- Provide DIN VDE 0100, Part 701 compliant safety zone 2
- Provided by customer: Zigbee gateway
- Not suitable for use in a steam room.

includes light bulbs with a Class G energy efficiency

includes light bulbs with a Class G energy efficiency

	Chrome	41 771 979-00
	Dark Chrome	41 771 979-19
	Brushed Bronze	41 771 979-42
	Brushed Champagne (22kt Gold)	41 771 979-46
	Champagne (22kt Gold)	41 771 979-47
	Brushed Stainless Steel	41 771 979-86
	Brushed Dark Platinum	41 771 979-99

Required miscellaneous



SERENITY SKY Concealed ceiling installation box with light - 35 771 970 90

- concealed rough parts
- flush-mounted reflection box, 662 x 482 mm, RAL 9003, Signal White
- 2x female thread 1/2" connections
- min. recess depth 150 mm
- weight 15kg
- Supply pipe 7 m
- Input 100-240V AC 50-60Hz
- Output 24V DC SELV / Class II
- ZigBee Light Link RGBW controller
- Provided by customer: Zigbee gateway



SERENITY SKY Rain panel for recessed ceiling installation with light - Chrome

41 771 979

mm [inches]
1:10

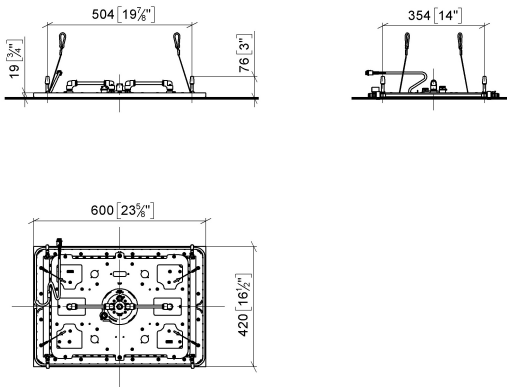

Flow rate chart

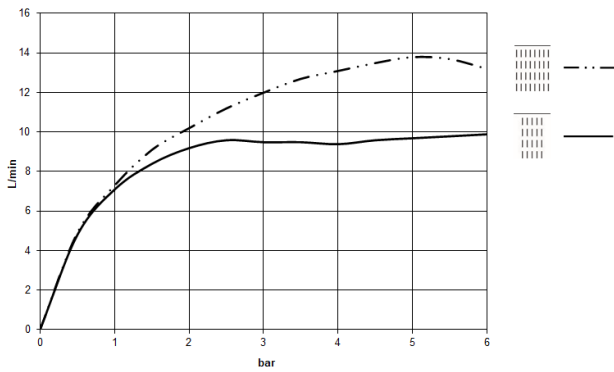



SERENITY SKY Rain panel for recessed ceiling installation with light - Chrome

41 771 979



SERENITY SKY Rain panel for recessed ceiling installation with light - Chrome

41 771 979

Spare parts list