







ST 050 200 1360



- slide bar
- Pipe diameter 18 mm
- rosette Ø 60 mm
- gauge 850 mm
- metal shower hose 1750mm with integrated anti-twist protection
- shower hose connector 1/2"
- COMPACT RAIN, max. flow rate 9 l/min (at 3 bar)
- spray head Ø 64mm
- This product can help a building meet the requirements of Green Building Rating Systems, e.g. LEED®, BREEAM®, DGNB

	Brushed Platinum	ST 050 200 1360-06
	Chrome	ST 050 200 1360-00
	Platinum	ST 050 200 1360-08
	Durabrace (23kt Gold)	ST 050 200 1360-09
	Brushed Durabrace (23kt Gold)	ST 050 200 1360-28
	Brushed Dark Platinum	ST 050 200 1360-99

Individual components of this set

You need the following components for this set



1x 28 002 970-06



1x 26 413 360-06



MADISON Shower set - Brushed Platinum

MADISON















ST 050 200 1360

ST 050 200 1360



- COMPACT RAIN, max. flow rate 9 l/min (at 3 bar)
- Function from: 6 l/min
- spray head Ø 64mm
- 1/2" connection
- WRAS 240502026, 1809019

Intrinsic protection against back flow.

	Brushed Platinum	28 002 970-06
	Chrome	28 002 970-00
	Chrome	28 002 970-00 0010
	Gold (23.9kt)	28 002 970-01
	Brushed Platinum	28 002 970-06 0010
	Platinum	28 002 970-08
	Platinum	28 002 970-08 0010
	Durabass (23kt Gold)	28 002 970-09
	Durabass (23kt Gold)	28 002 970-09 0010
	Brushed Durabass (23kt Gold)	28 002 970-28
	Brushed Durabass (23kt Gold)	28 002 970-28 0010
	Brushed Chrome	28 002 970-93
	Brushed Chrome	28 002 970-93 0010
	Brushed Dark Platinum	28 002 970-99
	Brushed Dark Platinum	28 002 970-99 0010

ST 050 200 1360

mm [inches]



Flow rate chart

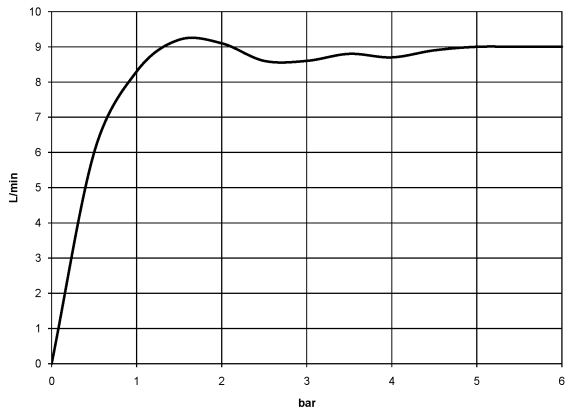

Certificates

LGA_8492.

WRAS_240502026.

ST 050 200 1360

Parts for other finishes can be found here: [Chrome](#)

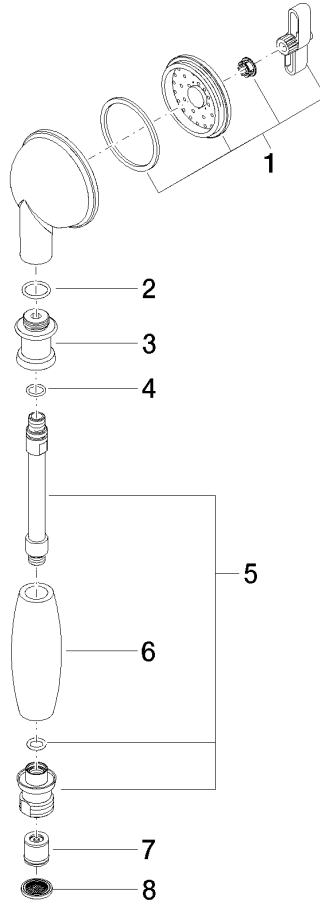

Spare parts list







No.	Item Number	Name	Quantity used	Delivery time
1	90 12 01 010 00 90	set	1	2
2	09 14 10 069 90	seal	1	2
3	09 24 04 059 20-06	nipple	1	10
4	09 14 10 042 90	seal	1	2
5	90 28 22 033 00-06	insert	1	-
Spare part can no longer be ordered, please order the replacement item				
6	11 167 820 60	handle	1	2
7	09 23 01 077 90	flow reducer	1	2
8	09 23 01 039 90	sieve	1	2

ST 050 200 1360



- slide bar
- Pipe diameter 18 mm
- rosette Ø 60 mm
- gauge 850 mm
- metal shower hose 1750mm with integrated anti-twist protection
- shower hose connector 1/2"
- WRAS 2009048

This article does not include a hand shower!

	Brushed Platinum	26 413 360-06
	Chrome	26 413 360-00
	Platinum	26 413 360-08
	Durabress (23kt Gold)	26 413 360-09
	Brushed Durabress (23kt Gold)	26 413 360-28
	Brushed Dark Platinum	26 413 360-99

Recommended miscellaneous

	Concealed wall elbow - •max. recess depth 163 mm •min. recess depth 90 mm	35 085 970 90
---	--	---------------

Recommended miscellaneous

	MADISON Wall elbow - Brushed Platinum	28 450 410-06
---	--	---------------

Required miscellaneous

	MADISON Hand shower FlowReduce - Brushed Platinum •spray head Ø 95mm •Hand shower see page (PAGE) •Three settings: COMPACT RAIN, COMPACT SOFT FLOW, COMPACT AQUAPRESSURE FLOW, max. flow rate l/min (at 3 bar)	28 002 978-06 0010
---	--	-----------------------

Required miscellaneous

	MADISON Hand shower - Brushed Platinum •spray head Ø 95mm •Hand shower see page (PAGE) •Three settings: COMPACT RAIN, COMPACT SOFT FLOW, COMPACT AQUAPRESSURE FLOW, max. flow rate l/min (at 3 bar)	28 002 978-06
---	---	---------------

Required miscellaneous

	MADISON Metal hand shower with porcelain insert (white) FlowReduce - Brushed Platinum	28 002 970-06 0010
---	--	-----------------------



MADISON Shower set - Brushed Platinum

MADISON

ST 050 200 1360

ST 050 200 1360

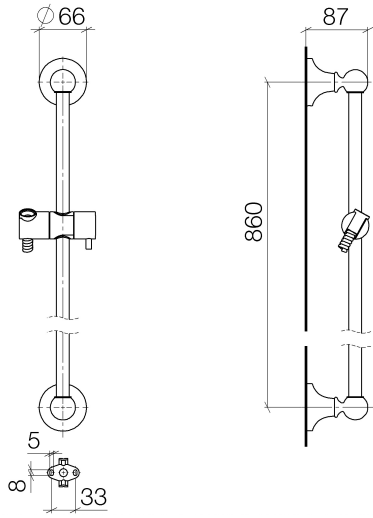

Certificates

WRAS_2009048. IAPMO_4976 (4).

ST 050 200 1360

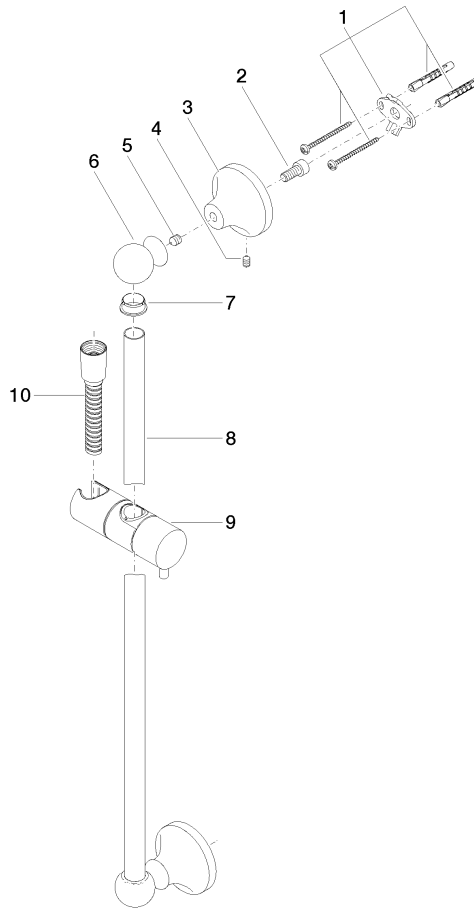

Spare parts list

No.	Item Number	Name	Quantity used	Delivery time
1	90 17 20 708 00 90	fixing set	2	2
2	09 30 30 048 90	screw	2	2
3	09 17 20 016-06	holder	2	10
4	09 31 11 144 90	pin	2	2
5	09 31 11 002 90	pin	2	2
6	09 21 40 020-06	connection	2	60
7	09 18 40 009 90	sleeve	2	2
8	08 28 22 596-06	pipe	1	60
9	12 580 970-06	Slide unit - Brushed Platinum	1	10
10	28 204 970-06	Metal shower hose 1/2" x 1/2" x 1750 mm - Brushed Platinum	1	2