







ST 050 301 6360



- shower with fixed riser projection 420mm
- Rain shower: PURE RAIN, max. flow rate 14 l/min (at 3 bar)
- Function from: 8 l/min
- rain shower Ø 200 mm
- Hand shower: COMPACT RAIN, max. flow rate 9 l/min (at 3 bar)
- spray head Ø 64mm
- rotary diverter for fixed-riser shower/hand shower
- height of fittings up to top edge of elbow 1180mm
- height of fittings up to rain shower (bottom edge) 1009mm
- rosette for shower holder Ø 66mm
- rosette for wall mounting Ø 70mm
- rosette for shower mixer Ø 60mm
- gauge 150 mm - 13 mm
- metal shower hose 1250mm with integrated anti-twist protection
- 1/2" connection
- Pipe diameter 20 mm

	Brushed Platinum	ST 050 301 6360-06
	Chrome	ST 050 301 6360-00
	Platinum	ST 050 301 6360-08
	Durabronze (23kt Gold)	ST 050 301 6360-09
	Brushed Durabronze (23kt Gold)	ST 050 301 6360-28
	Brushed Dark Platinum	ST 050 301 6360-99

**Individual components of this set**

You need the following components for this set

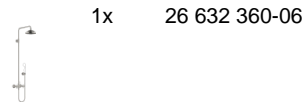
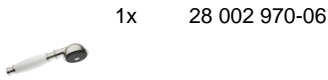



## MADISON Showerpipe with shower mixer - Brushed Platinum

---

MADISON

ST 050 301 6360

ST 050 301 6360



- COMPACT RAIN, max. flow rate 9 l/min (at 3 bar)
- Function from: 6 l/min
- spray head Ø 64mm
- 1/2" connection
- WRAS 240502026, 1809019

Intrinsic protection against back flow.

	Brushed Platinum	28 002 970-06
	Chrome	28 002 970-00
	Chrome	28 002 970-00 0010
	Gold (23.9kt)	28 002 970-01
	Brushed Platinum	28 002 970-06 0010
	Platinum	28 002 970-08
	Platinum	28 002 970-08 0010
	Durabass (23kt Gold)	28 002 970-09
	Durabass (23kt Gold)	28 002 970-09 0010
	Brushed Durabass (23kt Gold)	28 002 970-28
	Brushed Durabass (23kt Gold)	28 002 970-28 0010
	Brushed Chrome	28 002 970-93
	Brushed Chrome	28 002 970-93 0010
	Brushed Dark Platinum	28 002 970-99
	Brushed Dark Platinum	28 002 970-99 0010

ST 050 301 6360

mm [inches]

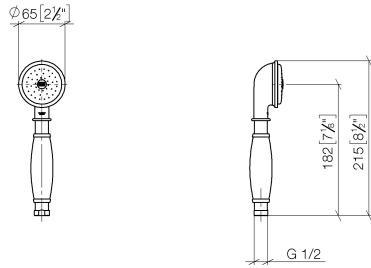

**Flow rate chart**

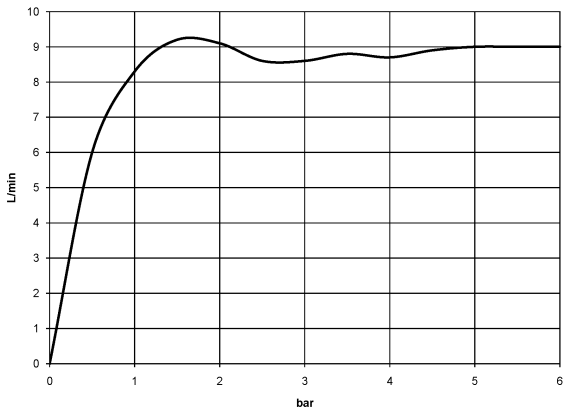

**Certificates**

LGA\_8492.

WRAS\_240502026.

ST 050 301 6360

Parts for other finishes can be found here: [Chrome](#)

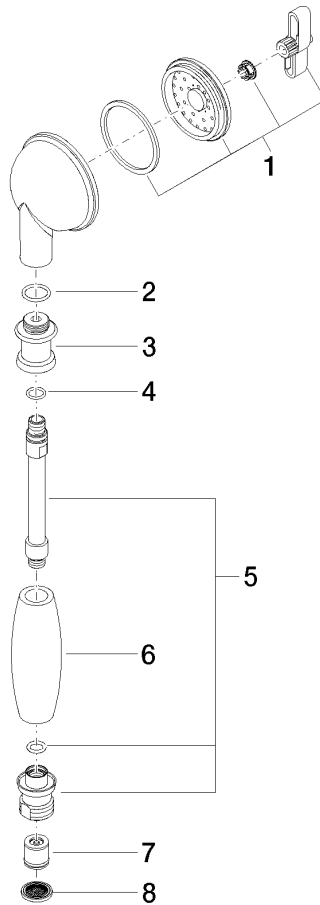







**Spare parts list**

No.	Item Number	Name	Quantity used	Delivery time
1	90 12 01 010 00 90	set	1	2
2	09 14 10 069 90	seal	1	2
3	09 24 04 059 20-06	nipple	1	10
4	09 14 10 042 90	seal	1	2
5	90 28 22 033 00-06	insert	1	-
Spare part can no longer be ordered, please order the replacement item				
6	11 167 820 60	handle	1	2
7	09 23 01 077 90	flow reducer	1	2
8	09 23 01 039 90	sieve	1	2

ST 050 301 6360



- shower with fixed riser projection 420mm
- overhead shower: rain flow
- rain shower Ø 200 mm
- max. rainshower flow 14 l/min
- Function from: 8 l/min
- rotary diverter for fixed-riser shower/hand shower
- height of fittings up to top edge of elbow 1180mm
- height of fittings up to rain shower (bottom edge) 1009mm
- rosette for shower holder Ø 66mm
- rosette for wall mounting Ø 70mm
- rosette for shower mixer Ø 60mm
- gauge 150 mm - 13 mm
- metal shower hose 1250mm with integrated anti-twist protection
- 1/2" connection
- Pipe diameter 20 mm
- This product can help a building meet the requirements of Green Building Rating Systems, e.g. LEED®, BREEAM®, DGNB
- WRAS 2204012

	Brushed Platinum	26 632 360-06
	Chrome	26 632 360-00
	Platinum	26 632 360-08
	Durabress (23kt Gold)	26 632 360-09
	Brushed Durabress (23kt Gold)	26 632 360-28
	Brushed Dark Platinum	26 632 360-99

This article does not include a hand shower!

Intrinsic protection against back flow.

**Required miscellaneous**

- |  |   |               |
|--|---|---------------|
|  | <b>MADISON Hand shower - Brushed Platinum</b>   | 28 002 978-06 |
|  | <ul style="list-style-type: none"> <li>• spray head Ø 95mm</li> <li>• Hand shower see page {PAGE}</li> <li>• Three settings: COMPACT RAIN, COMPACT SOFT FLOW, COMPACT AQUAPRESSURE FLOW, max. flow rate l/min (at 3 bar)</li> </ul> |               |

**Required miscellaneous**

- |  |  |                       |
|--|--|-----------------------|
|  | <b>MADISON Metal hand shower with porcelain insert (white) FlowReduce - Brushed Platinum</b> | 28 002 970-06<br>0010 |
|--|--|-----------------------|

**Required miscellaneous**

- |   |   |                       |
|---|---|-----------------------|
|  | <b>MADISON Hand shower FlowReduce - Brushed Platinum</b>  | 28 002 978-06<br>0010 |
|   | <ul style="list-style-type: none"> <li>• spray head Ø 95mm</li> <li>• Hand shower see page {PAGE}</li> <li>• Three settings: COMPACT RAIN, COMPACT SOFT FLOW, COMPACT AQUAPRESSURE FLOW, max. flow rate l/min (at 3 bar)</li> </ul> |                       |



## MADISON Showerpipe with shower mixer - Brushed Platinum

---

MADISON

ST 050 301 6360

ST 050 301 6360

mm [inches]

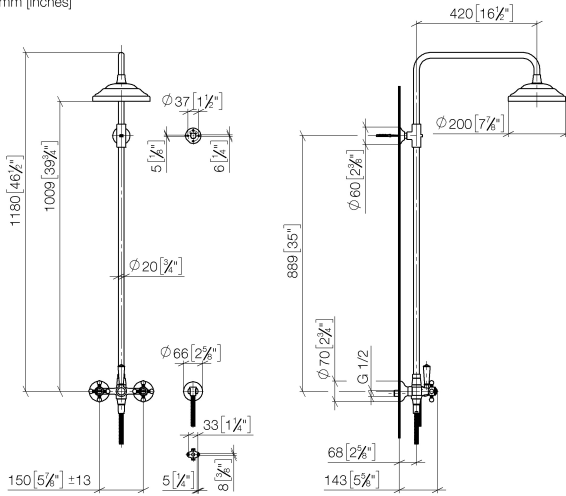

**Flow rate chart**

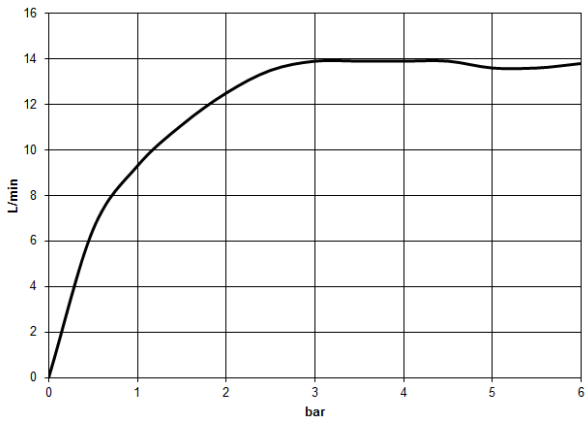

**Certificates**

Belgaqua\_21-023- WRAS\_2204012.  
27\_8.



ST 050 301 6360

Parts for other finishes can be found here: [Chrome](#)

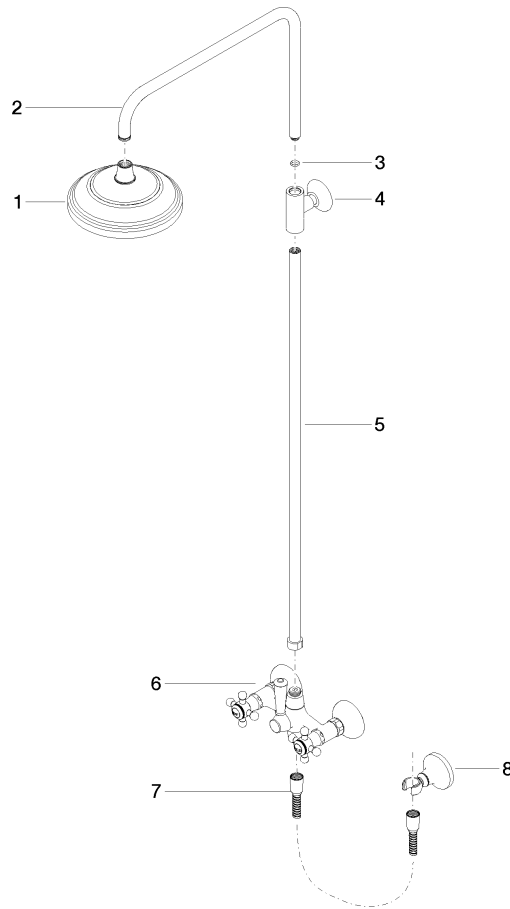

**Spare parts list**

No.	Item Number	Name	Quantity used	Delivery time
1	04 12 05 038 01-06	shower	1	60
2	04 28 22 101 20-06	spout	1	10
3	90 14 10 011 00 90	seal	1	2
4	90 17 11 033 00-06	holder	1	-
Spare part can no longer be ordered, please order the replacement item				
5	90 28 22 096 00-06	pipe	1	10
6	04 17 10 001 00-06	fitting	1	60
7	28 104 970-06	Metal shower hose 1/2" x 1/2" x 1250 mm - Brushed Platinum	1	2
8	28 050 410-06	holder	1	60