

ST 050 306 0980



Fits: IMO, MEM, CL.1, CYO

- shower with fixed riser projection 453mm
- Rain shower: PURE RAIN, max. flow rate 20 l/min (at 3 bar)
- Function from: 12 l/min
- rain shower 300 x 240mm
- rain shower with anti-scale system
- Hand shower: COMPACT RAIN, max. flow rate 15 l/min (at 3 bar)
- spray head Ø 100mm
- rotary diverter with volume control and shut-off function
- slide-on rosettes Ø 70 mm
- height of fittings up to rain shower (bottom edge) 1009mm
- height of fittings up to top edge of elbow 1150mm
- gauge 150 mm - 13 mm
- metal shower hose 1750mm with integrated anti-twist protection
- 1/2" connection
- slide bar
- Pipe diameter 23.5 mm

	Brushed Platinum	ST 050 306 0980-06
	Chrome	ST 050 306 0980-00
	Platinum	ST 050 306 0980-08
	Dark Chrome	ST 050 306 0980-19
	Brushed Light Gold	ST 050 306 0980-27
	Brushed Durabrass (23kt Gold)	ST 050 306 0980-28
	Matte Black	ST 050 306 0980-33
	Brushed Champagne (22kt Gold)	ST 050 306 0980-46
	Champagne (22kt Gold)	ST 050 306 0980-47
	Brushed Dark Platinum	ST 050 306 0980-99

Individual components of this set

You need the following components for this set



1x 34 459 980-06



1x 28 018 979-06



SYMETRICS Showerpipe with shower thermostat - Brushed Platinum

IMO

ST 050 306 0980

ST 050 306 0980



Fits: IMO, MEM, CL.1, CYO

- shower with fixed riser projection 453mm
- overhead shower: rain flow
- rain shower 300 x 240mm
- rain shower with anti-scale system
- max. rainshower flow 20 l/min
- Function from: 12 l/min
- rotary diverter with volume control and shut-off function
- slide-on rosettes Ø 70 mm
- height of fittings up to rain shower (bottom edge) 1009mm
- height of fittings up to top edge of elbow 1150mm
- gauge 150 mm - 13 mm
- metal shower hose 1750mm with integrated anti-twist protection
- 1/2" connection
- slide bar
- Pipe diameter 23.5 mm
- quick clearing
- WRAS 2204013

This article does not include a hand shower!
Intrinsic protection against back flow.

	Brushed Platinum	34 459 980-06
	Chrome	34 459 980-00
	Platinum	34 459 980-08
	Dark Chrome	34 459 980-19
	Brushed Light Gold	34 459 980-27
	Brushed Durabronze (23kt Gold)	34 459 980-28
	Matte Black	34 459 980-33
	Brushed Champagne (22kt Gold)	34 459 980-46
	Champagne (22kt Gold)	34 459 980-47
	Brushed Chrome	34 459 980-93
	Brushed Dark Platinum	34 459 980-99

Required miscellaneous

	Hand shower FlowReduce - Brushed Platinum	28 012 979-06 0010
--	--	-----------------------

Required miscellaneous

	Hand shower - Brushed Platinum	28 016 979-06
--	---------------------------------------	---------------

Required miscellaneous

	Hand shower FlowReduce - Brushed Platinum	28 016 979-06 0010
--	--	-----------------------

Required miscellaneous

	Hand shower FlowReduce - Brushed Platinum	28 018 979-06 0010
--	--	-----------------------

Required miscellaneous

	Hand shower - Brushed Platinum	28 017 979-06
--	---------------------------------------	---------------

Required miscellaneous

	Hand shower - Brushed Platinum	28 012 979-06
--	---------------------------------------	---------------

Required miscellaneous

	Hand shower - Brushed Platinum	28 018 979-06
--	---------------------------------------	---------------

ST 050 306 0980

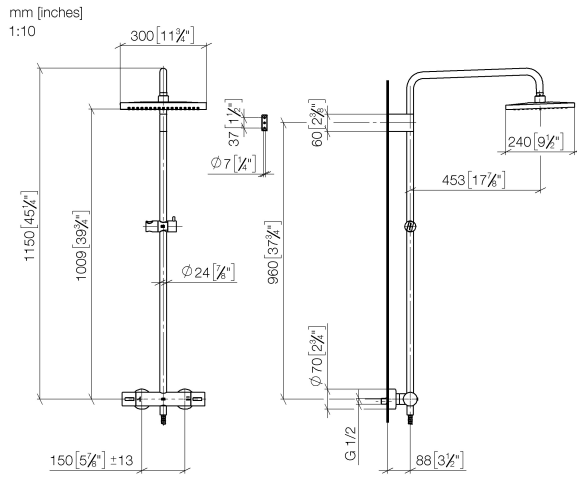

Flow rate chart

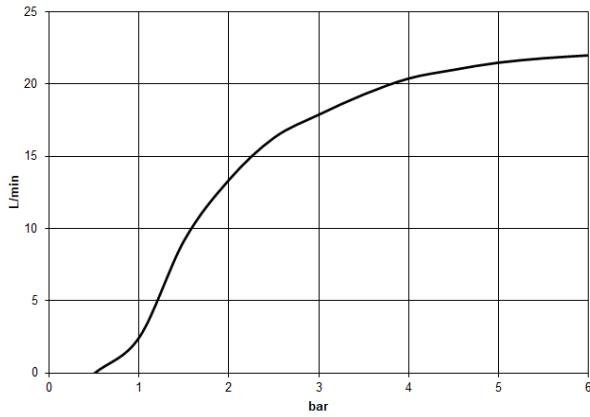

Certificates

LGA_29987. Belgaqua_21-032- WRAS_2204013. LGA_38669.
27_5.

ST 050 306 0980

Parts for other finishes can be found here: [Chrome](#)

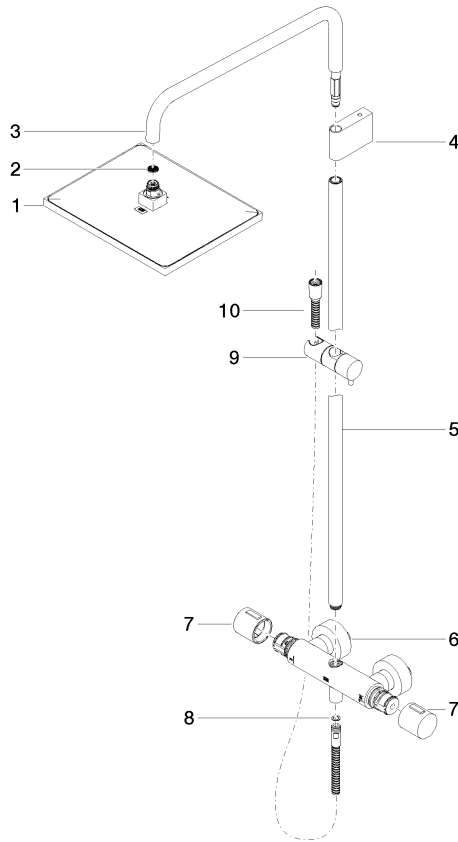

Spare parts list

No.	Item Number	Name	Quantity used	Delivery time
1	04 12 05 063 00-06	shower	1	10
2	09 23 01 039 90	sieve	1	2
3	90 28 22 348 00-06	pipe	1	10
4	90 17 11 150 00-06	holder	1	10
5	90 28 22 349 00-06	pipe	1	10
6	04 17 01 250 00-06	connection	1	10
7	90 17 33 015 00-06	handle	2	10
8	90 14 20 026 00 90	seal	1	2
9	12 570 970-06	Slide unit - Brushed Platinum	1	10
10	28 322 970-06	Metal shower hose 1/2" x 3/8" x 1750 mm - Brushed Platinum	1	2

SYMETRICS Showerpipe with shower thermostat - Brushed Platinum

IMO





























ST 050 306 0980



- Three or five settings: COMPACT RAIN, COMPACT SOFT FLOW, COMPACT AQUAPRESSURE FLOW, max. flow rate 15 l/min (at 3 bar)
- with anti-scale system
- spray head Ø 100mm
- 1/2" connection
- WRAS 2210003
- Function from: 7 l/min

Intrinsic protection against back flow.

Fits: IMO, LULU, MADISON, MEM, TARA, CL.1, LISSÉ, VAIA, META, CYO

	Brushed Platinum	28 018 979-06
	Chrome	28 018 979-00
	Chrome	28 018 979-00 0010
	Brushed Platinum	28 018 979-06 0010
	Platinum	28 018 979-08
	Platinum	28 018 979-08 0010
	Dark Brass matt	28 018 979-16 0010
	Dark Bronze matt	28 018 979-17 0010
	Dark Chrome	28 018 979-19
	Dark Chrome	28 018 979-19 0010
	Light Gold	28 018 979-26 0010
	Light Gold	28 018 979-26
	Brushed Light Gold	28 018 979-27 0010
	Brushed Light Gold	28 018 979-27
	Brushed Durabronze (23kt Gold)	28 018 979-28
	Brushed Durabronze (23kt Gold)	28 018 979-28 0010
	Matte Black	28 018 979-33
	Matte Black	28 018 979-33 0010
	Brushed Bronze	28 018 979-42
	Brushed Bronze	28 018 979-42 0010
	Brushed Champagne (22kt Gold)	28 018 979-46
	Brushed Champagne (22kt Gold)	28 018 979-46 0010
	Champagne (22kt Gold)	28 018 979-47
	Champagne (22kt Gold)	28 018 979-47 0010
	Brushed Chrome	28 018 979-93
	Brushed Chrome	28 018 979-93 0010
	Brushed Dark Platinum	28 018 979-99
	Brushed Dark Platinum	28 018 979-99 0010



SYMETRICS Showerpipe with shower thermostat - Brushed Platinum

IMO

ST 050 306 0980



SYMETRICS Showerpipe with shower thermostat - Brushed Platinum

IMO

ST 050 306 0980



SYMETRICS Showerpipe with shower thermostat - Brushed Platinum

IMO

ST 050 306 0980

ST 050 306 0980

mm [inches]

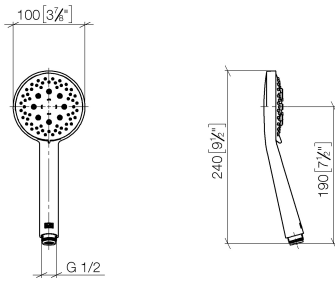

Flow rate chart



Certificates

LGA_29984.

DVGW_DW-
6517DN0129.

WRAS_2210003.

ST 050 306 0980

Parts for other
finishes can be found
here: [Chrome](#)



Spare parts list

No.	Item Number	Name	Quantity used	Delivery time
1	09 23 01 039 90	sieve	1	2