







ST 110 201 5892



- 235mm projection
- pivotable spout 360°
- air-enriched flow and spray flow
- height of mixer 370 mm
- test
- height up to aerator 212 mm
- hole diameter spout 35 mm
- hole diameter valve 32 mm
- profi spray hole diameter 30mm
- automatic spout/shower diverter
- sprayface with anti-scaling system
- max. flow 7 l/min at 3 bar flow pressure
- lead-free
- This product can help a building meet the requirements of Green Building Rating Systems, e.g. LEED®, BREEAM®, DGNB

	Brushed Dark Platinum	ST 110 201 5892-99
	Chrome	ST 110 201 5892-00
	Brushed Platinum	ST 110 201 5892-06
	Platinum	ST 110 201 5892-08
	Dark Chrome	ST 110 201 5892-19
	Brushed Chrome	ST 110 201 5892-93

Individual components of this set

You need the following components for this set



1x 20 815 892-99



1x 27 789 970-99



TARA Three-hole mixer with profi spray set - Brushed Dark Platinum

TARA

ST 110 201 5892

ST 110 201 5892



- 235mm projection
- pivotable spout 360°
- air-enriched flow
- height of mixer 370 mm
- height up to aerator 212 mm
- hole diameter spout 35 mm
- hole diameter valve 32 mm
- max. flow 7 l/min at 3 bar flow pressure
- lead-free
- This product can help a building meet the requirements of Green Building Rating Systems, e.g. LEED®, BREEAM®, DGNB
- WRAS 2107052

	Brushed Dark Platinum	20 815 892-99
	Chrome	20 815 892-00
	Brushed Platinum	20 815 892-06
	Platinum	20 815 892-08
	Durabronze (23kt Gold)	20 815 892-09
	Dark Chrome	20 815 892-19
	Brushed Durabronze (23kt Gold)	20 815 892-28
	Matte Black	20 815 892-33
	Brushed Champagne (22kt Gold)	20 815 892-46
	Champagne (22kt Gold)	20 815 892-47
	Brushed Chrome	20 815 892-93

Recommended miscellaneous

Strainer waste with control handle - Brushed Dark Platinum 10 710 970-99



Recommended miscellaneous

Dispenser with rosette - Brushed Dark Platinum 82 444 970-99



ST 110 201 5892

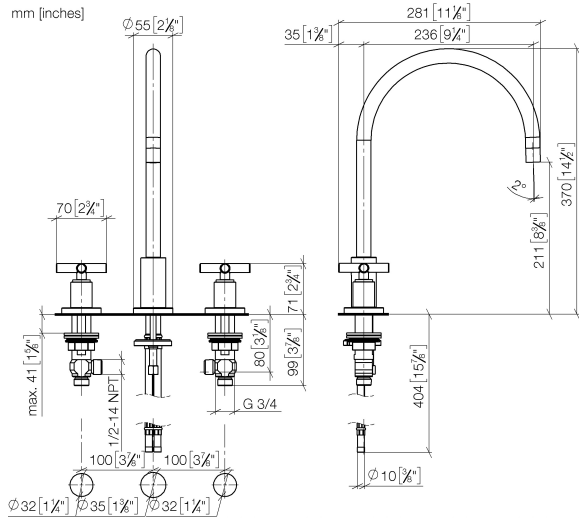

Flow rate chart

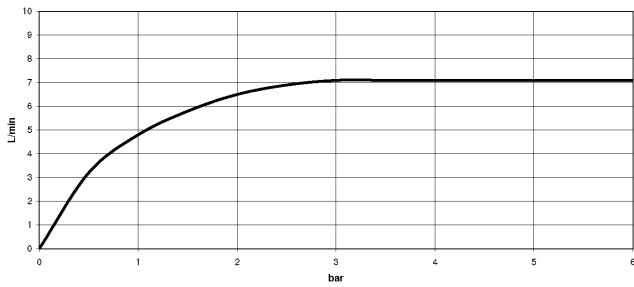

Certificates

WRAS_2107052.

ETA_18514.

LGA_19166.

GDV_0400289.

ST 110 201 5892

Parts for other finishes can be found here: [Chrome](#)

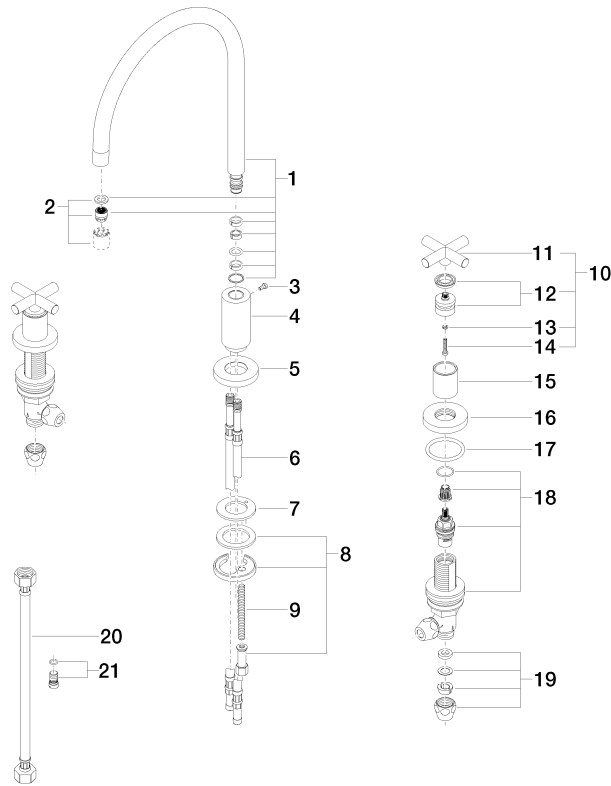

Spare parts list

No.	Item Number	Name	Quantity used	Delivery time
1	90 28 22 226 01-99	spout	1	30
2	90 23 01 028 03-99	aerator	1	30
3	09 30 30 057 90	screw	1	2
4	09 11 10 088 10-99	connection	1	30
5	09 28 10 140-99	ring	1	30
6	04 30 04 019 00 90	hose	2	2
7	09 14 05 047 90	seal	1	2
8	04 30 11 038 00 90	fixing set	1	2
9	09 31 11 011 90	pin	1	2
10	90 20 89 010 10-99	handle	2	30
11	09 20 89 010-99	handle	2	60
12	90 12 12 007 00-99	base	2	30
13	90 30 11 029 00 90	disc	2	2
14	90 30 30 075 00 90	screw	2	2
15	09 21 02 140-99	sleeve	2	30
16	09 27 89 105-99	rosette	2	30
17	90 14 10 043 00 90	seal	2	2
18	90 17 11 040 51 90	side panel	2	2
19	90 23 30 040 00-99	threaded connector	4	30
20	12 501 970 90	High pressure hose 1/2" x 1/2" x 300 mm -	2	-
Spare part can no longer be ordered, please order the replacement item				
21	04 31 20 046 10 92	set	1	2

ST 110 201 5892









Fits: ELIO, TARA, TARA ULTRA

- spray flow
- automatic diverter for spout/Profi spray set
- height of mixer 665 mm
- individual rosette diameter 55mm
- profi spray hole diameter 30mm
- sprayface with anti-scaling system
- lead-free

Can only be combined with 33826790, 32800790, 33826888, 32815888, 20815892, 33826875.

Intrinsic protection against back flow.

	Brushed Dark Platinum	27 789 970-99
	Chrome	27 789 970-00
	Brushed Platinum	27 789 970-06
	Platinum	27 789 970-08
	Dark Chrome	27 789 970-19
	Brushed Chrome	27 789 970-93



TARA Three-hole mixer with profi spray set - Brushed Dark Platinum

TARA

ST 110 201 5892

ST 110 201 5892

mm [inches]
M 1:10

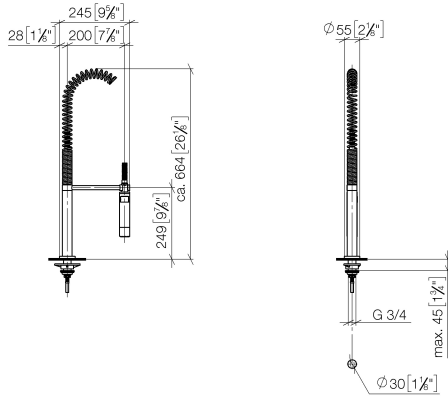

Flow rate chart

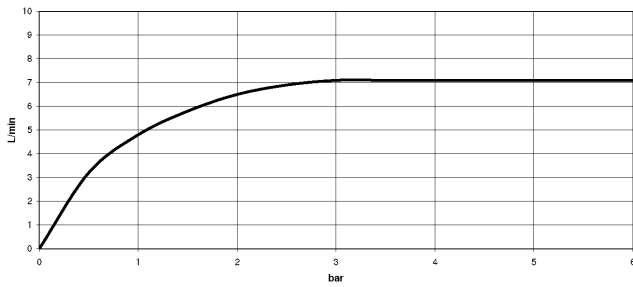

Certificates

LGA_18901. Belgaqua_22_277_2
7_3.

ST 110 201 5892

Parts for other finishes can be found here: [Chrome](#)

