







13 801 845



- saillie 210 mm
- jet normal circulaire
- diamètre de percement 37 mm
- raccord 1/2"
- montage de la fiche
- débit d'eau maxi. 21,5 l/min avec une pression d'écoulement de 3 bars

	Platine brossé	13 801 845-06
	Chrome	13 801 845-00
	Dark Chrome	13 801 845-19
	Or clair brossé	13 801 845-27
	Noir mat	13 801 845-33
	Chrome brossé	13 801 845-93
	Dark Platinum brossé	13 801 845-99

### Accessoires recommandés



- Coude mural à encastrer -** 35 085 970 90
- profondeur de montage max. 163 mm
  - profondeur de montage mini. 90 mm

13 801 845

mm [inches]

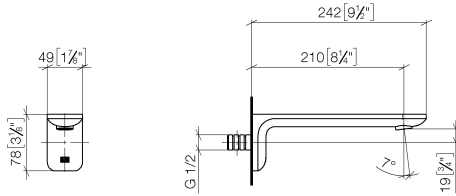

**Diagramme de débit**

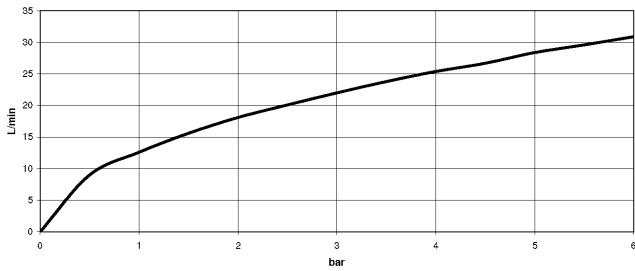

**Codes & Standards**

ASME A112.18.1

cUPC

DIN 4109

ISO 3822

Scottish Water  
Byelaws

UK Water Supply  
Regulations

Ü-Zeichen



## LISSÉ Bec déverseur de bain pour montage mural - Platine brossé

---

LISSÉ

13 801 845

### Certificats

---

LGA\_29

IAPMO\_4976

WRAS\_2207

13 801 845

Version du produit de 3/9/2016

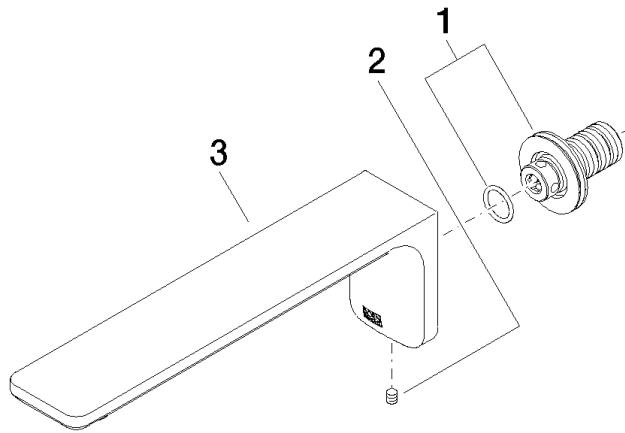



13 801 845

## Liste des pièces de rechange

Version du produit de 3/9/2016

N°	Article Numéro	Désignation	Fréquence de montage	Délai de livraison
	90 24 03 108 00 90	set deraccord à vis	3	2