







CL.1 Robinet latéral fermant à droite froid - Chrome

CL.1

20 000 705



- diamètre de percement des robinets latéraux 32 mm
- rosace 60 x 60 mm
- avec marquage froid

	Chrome	20 000 705-00
	Platine brossé	20 000 705-06
	Dark Chrome	20 000 705-19
	Champagne brossé (Or 22cts)	20 000 705-46
	Champagne (Or 22cts)	20 000 705-47
	Dark Platinum brossé	20 000 705-99

20 000 705

mm [inches]



Diagramme de débit



Codes & Standards

ASME A112.18.1

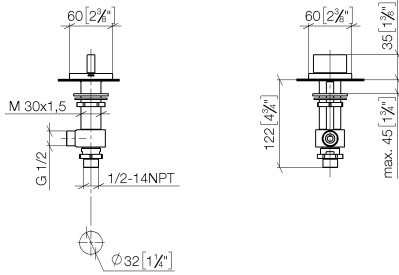
cUPC

DIN 4109

ISO 3822

Scottish Water
Byelaws

UK Water Supply
Regulations

Ü-Zeichen



CL.1 Robinet latéral fermant à droite froid - Chrome

CL.1

20 000 705

Certificats

IAPMO_4976

WRAS_2103

LGA_28

20 000 705

Version du produit de 3/9/2015

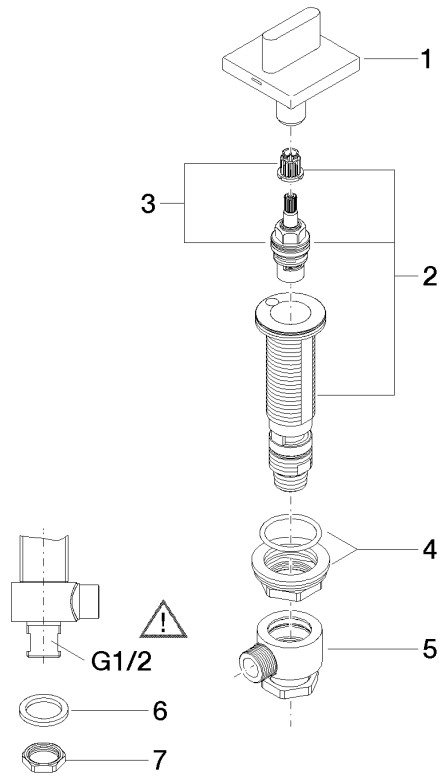



CL.1 Robinet latéral fermant à droite froid - Chrome

CL.1

20 000 705

Liste des pièces de rechange

Version du produit de 3/9/2015

N°	Article Numéro	Désignation	Fréquence de montage	Délai de livraison
	90 20 70 051 04-00	poignée (cold)	8	10