

Robinet latéral fermant à droite chaud - Chrome







CL.1

20 000 715



- diamètre de percement 32 mm
- rosace 60 x 60 mm
- avec marquage chaud

S'adapte aux gammes suivantes : CL.1, CYO

	Chrome	20 000 715-00
	Platine brossé	20 000 715-06
	Dark Chrome	20 000 715-19
	Champagne brossé (Or 22cts)	20 000 715-46
	Champagne (Or 22cts)	20 000 715-47
	Dark Platinum brossé	20 000 715-99

20 000 715

mm [inches]

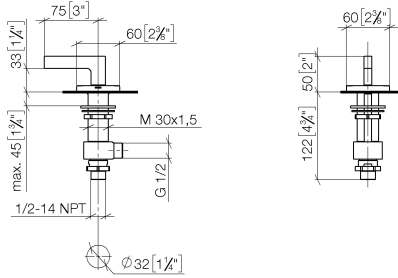

**Diagramme de débit**

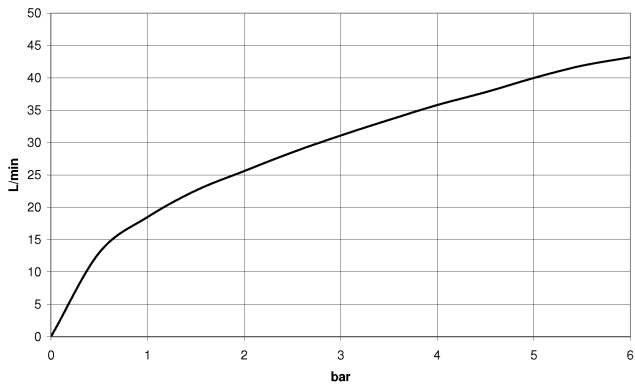

**Codes & Standards**

DIN 4109

ISO 3822

Ü-Zeichen



## Robinet latéral fermant à droite chaud - Chrome

---

CL.1

20 000 715

Certificats

---

LGA\_28

20 000 715

Version du produit de 6/1/2015

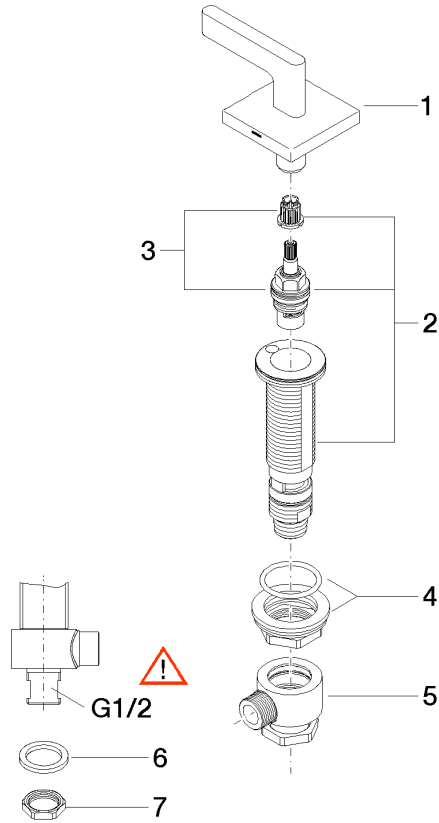



## Robinet latéral fermant à droite chaud - Chrome

CL.1

20 000 715

### Liste des pièces de rechange

#### Version du produit de 6/1/2015

N°	Article Numéro	Désignation	Fréquence de montage	Délai de livraison
	90 20 70 057 00-00	poignée ( hot )	7	10