







20 004 715

- diamètre de percement 32 mm
- rosace 60 x 47 mm
- avec marquage chaud



S'adapte aux gammes suivantes : CL.1, CYO

	Chrome	20 004 715-00
	Platine brossé	20 004 715-06
	Laiton brossé (Or 23cts)	20 004 715-28
	Champagne brossé (Or 22cts)	20 004 715-46
	Champagne (Or 22cts)	20 004 715-47
	Dark Platinum brossé	20 004 715-99

20 004 715

mm [inches]



Diagramme de débit



Certificats

IAPMO_4976 (5). IAPMO_N-4976. LGA_28687. IAPMO_6397.

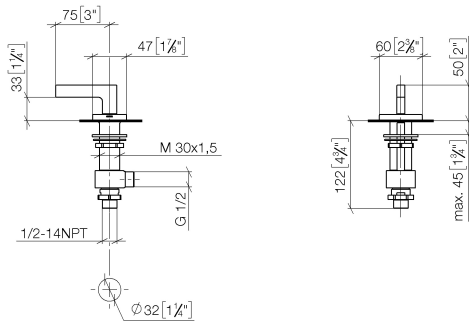
20 004 715

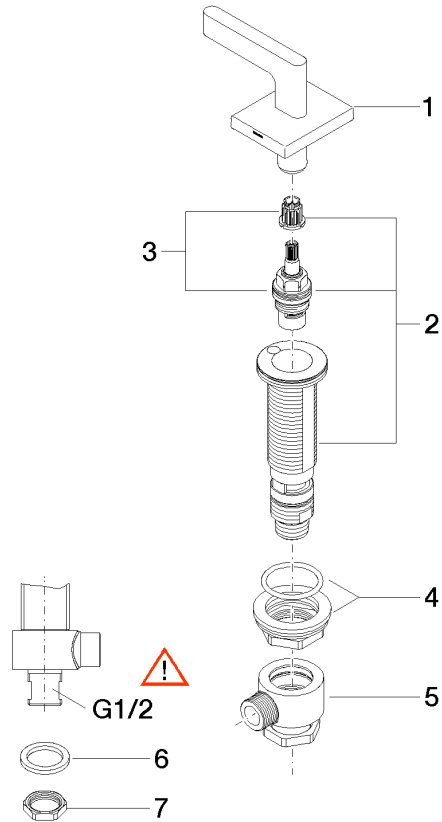

Liste des pièces de rechange

N°	Article Numéro	Désignation	Fréquence de montage	Délai de livraison
1	90 20 70 057 02-00	poignée (hot)	1	10
2	04 17 11 058 53 90	partie latérale	1	2
3	90 90 03 153 00 90	tête céramique	1	2
4	04 23 10 032 78 90	set de fixation	1	2
5	04 17 11 023 10 90	raccord multiple	1	2
6	09 30 11 059 90	rondelle	1	2
7	09 23 10 012 90	écrou	1	2