

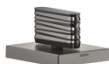





20 005 706

- avec structure WAVES
- diamètre de percement 32 mm
- rosace 60 x 47 mm
- avec marquage chaud



	Dark Platinum brossé	20 005 706-99
	Chrome	20 005 706-00
	Platine brossé	20 005 706-06
	Dark Chrome	20 005 706-19
	Champagne brossé (Or 22cts)	20 005 706-46
	Champagne (Or 22cts)	20 005 706-47

20 005 706

mm [inches]

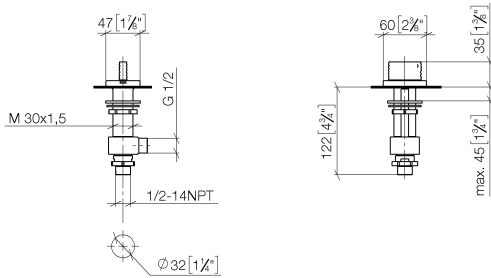

**Diagramme de débit**



**Certificats**

WRAS\_1804020. IAPMO\_N-4976. LGA\_28687. IAPMO\_4976 (4). IAPMO\_6397.

WRAS\_240202020.

20 005 706

Les pièces pour les autres finitions peuvent être trouvées ici : [Chrome](#)

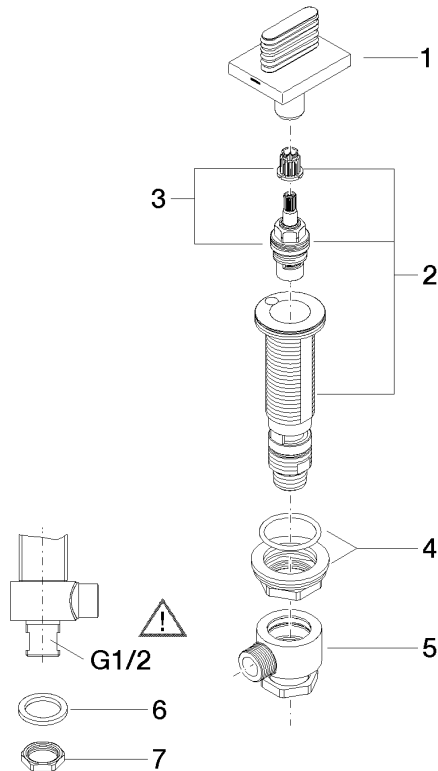

### Liste des pièces de rechange

N°	Article Numéro	Désignation	Fréquence de montage	Délai de livraison
1	90 20 70 055 07-99	poignée ( hot )	1	30
2	04 17 11 058 52 90	partie latérale	1	2
3	90 90 03 152 00 90	tête céramique	1	2
4	04 23 10 032 78 90	set de fixation	1	2
5	04 17 11 023 10 90	raccord multiple	1	2
6	90 23 30 040 00-99	joint américain	1	30
7	09 30 11 059 90	rondelle	1	2
8	09 23 10 012 90	écrou	1	2