







22 900 360

- rosace Ø 60 mm
- plaquette en porcelaine COLD



	Chrome	22 900 360-00
	Platine brossé	22 900 360-06
	Platine	22 900 360-08
	Laiton (Or 23cts)	22 900 360-09
	Laiton brossé (Or 23cts)	22 900 360-28
	Dark Platinum brossé	22 900 360-99

22 900 360



Diagramme de débit



22 900 360

Les pièces pour les autres finitions peuvent être trouvées ici : [Platine brossé](#)

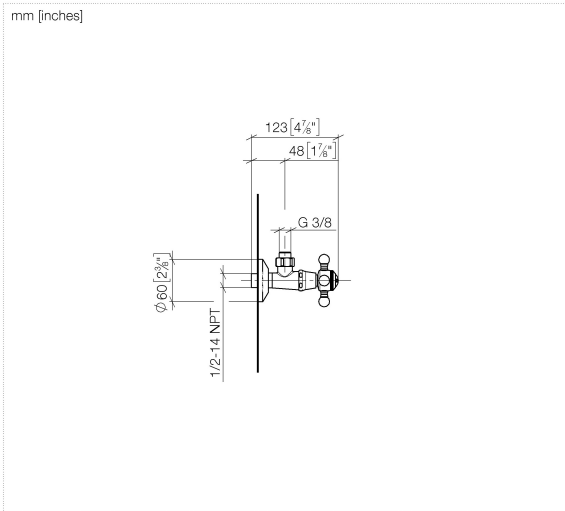
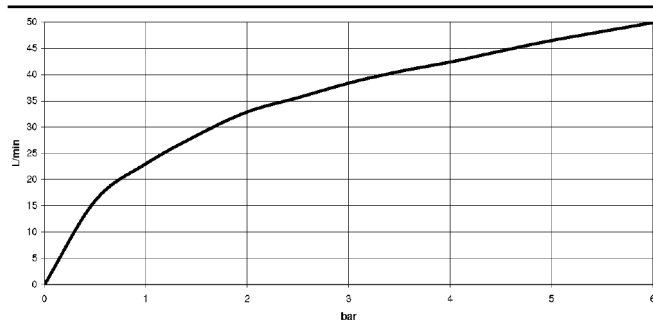
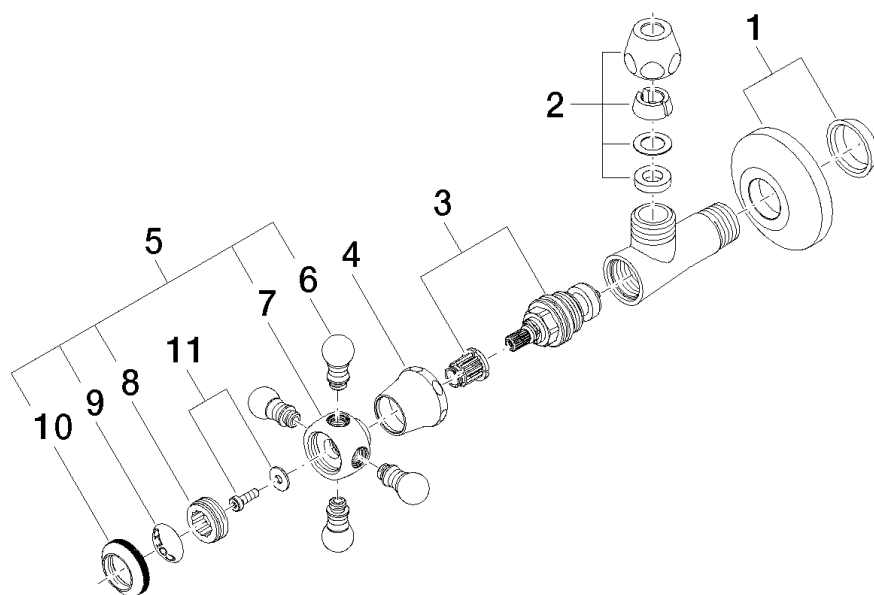

Liste des pièces de rechange

N°	Article Numéro	Désignation	Fréquence de montage	Délai de livraison
1	04 27 01 003 00-00	rosace	1	10
2	90 23 30 040 00-00	joint américain	1	10
3	90 90 03 023 01 90	tête céramique	1	2
4	09 21 02 055-00	hotte	1	10
5	04 20 36 002 06-00	poignée (cold)	1	10
6	09 20 36 004-00	poignée	4	10
7	09 20 36 002-00	poignée	1	10
8	09 20 83 006 90	poignée	1	2
9	09 26 01 010 90	accessoires	1	2
10	09 20 36 005-00	poignée	1	10
11	04 30 30 029 00 90	set de fixation	1	2