









27 838 979



S'adapte aux gammes suivantes : IMO,  
MEM, CL.1, CYO

- LAMINAR FLOW, débit max. 15 l/min (à 3 bar)
- sortie douche 3/8"
- plaque de recouvrement 240 x 60 mm
- flexible de douche métallique 1250 mm avec protection anti-torsion intégrée
- raccord 1/2"
- montage de la fiche

Avec sécurité anti-retour.

	Platine brossé	27 838 979-06
	Chrome	27 838 979-00
	Platine	27 838 979-08
	Dark Chrome	27 838 979-19
	Or clair brossé	27 838 979-27
	Laiton brossé (Or 23cts)	27 838 979-28
	Noir mat	27 838 979-33
	Chrome brossé	27 838 979-93
	Dark Platinum brossé	27 838 979-99

#### Accessoires recommandés



- Coude mural à encastrer -** 35 085 970 90
- profondeur de montage max. 163 mm
  - profondeur de montage mini. 90 mm

27 838 979

mm [inches]



Diagramme de débit



Certificats

Belgaqua\_21-023- LGA\_38675.  
27\_8.

27 838 979

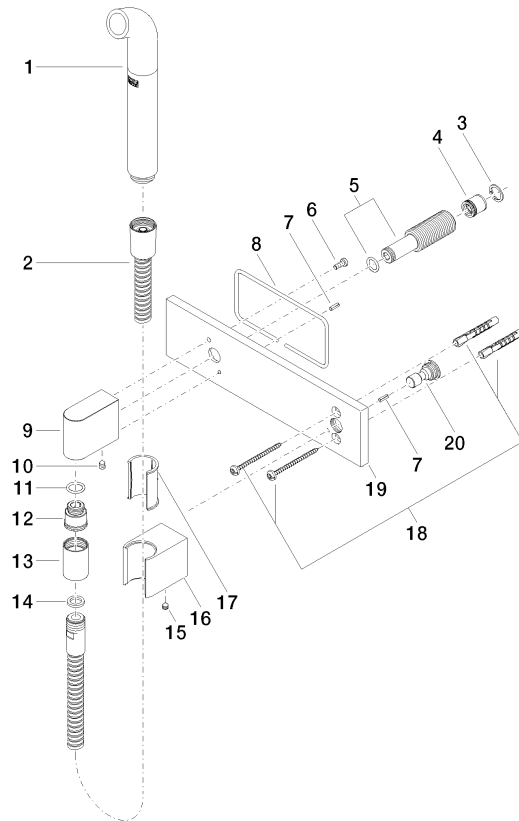

### Liste des pièces de rechange

N°	Article Numéro	Désignation	Fréquence de montage	Délai de livraison
1	04 12 11 073 01-06	bec déverseur	1	10
2	90 30 02 072 00-06	Flexible métallique de douche 1/2" x 3/8" x 1250 mm - Platine brossé	1	10
3	09 16 01 014 90	anneau	1	2
4	09 23 01 046 90	anti-retour	1	2
5	90 24 03 212 00 90	raccord à vis	1	2
6	09 14 10 008 90	joint	1	2
7	09 31 11 026 90	tige	2	2
8	09 14 03 127 90	joint	1	2
9	09 11 03 046-06	raccord	1	10
10	90 31 11 004 00 90	tige	1	2
11	90 14 10 077 00 90	joint	1	2
12	09 24 03 107 20 90	raccord à vis	1	2
13	90 21 02 069 00-06	hotte	1	10
14	90 14 20 026 00 90	joint	1	2
15	90 31 11 112 00 90	tige	1	2
16	09 17 20 044-06	patte de fixation	1	10
17	09 18 40 078 90	douille	1	2
18	05 30 31 025 00 90	set de fixation	1	2
19	09 11 02 133-06	plaque	1	10
20	09 24 03 073 90	raccord à vis	1	2