











32 815 875



- saillie 241 mm
- bec pivotant 360°
- en option, possibilité de limiter le pivotement avec un set de limitation de pivotement 12 820 970 90
- jet enrichi en air
- débit d'eau maxi. 8 l/min avec une pression d'écoulement de 3 bars
- sans plomb
- Ce produit contribue au respect des exigences des systèmes d'évaluation des bâtiments écologiques, par exemple LEED®, BREEAM®, DGNB

Mitigeur à positionner librement.

	Laiton (Or 23cts)	32 815 875-09
	Chrome	32 815 875-00
	Platine brossé	32 815 875-06
	Platine	32 815 875-08
	Dark Chrome	32 815 875-19
	Laiton brossé (Or 23cts)	32 815 875-28
	Noir mat	32 815 875-33
	Champagne brossé (Or 22cts)	32 815 875-46
	Champagne (Or 22cts)	32 815 875-47
	Chrome brossé	32 815 875-93
	Dark Platinum brossé	32 815 875-99

Accessoires recommandés

Kit de limitation de pivotement - 12 820 970 90



Accessoires recommandés

Commande de vidage individuelle manuelle Commande manuelle - Laiton (Or 23cts) 10 710 970-09



Accessoires recommandés

Distributeur avec rosace - Laiton (Or 23cts) 82 444 970-09



32 815 875
mm [inches]
1:5



Diagramme de débit



Certificats

LGA_38639.

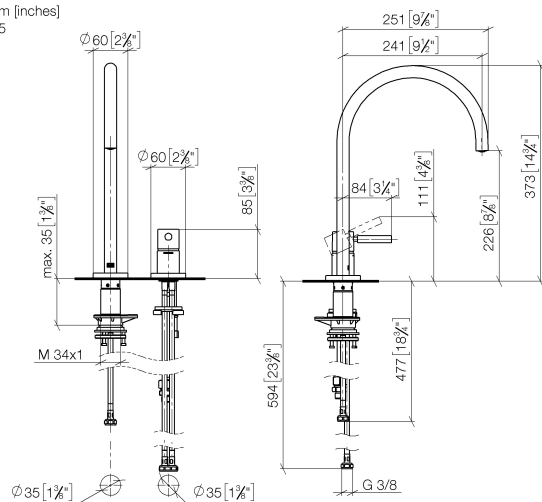
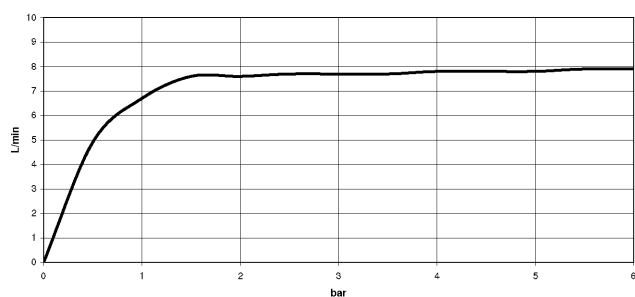
WRAS_240102014.

32 815 875

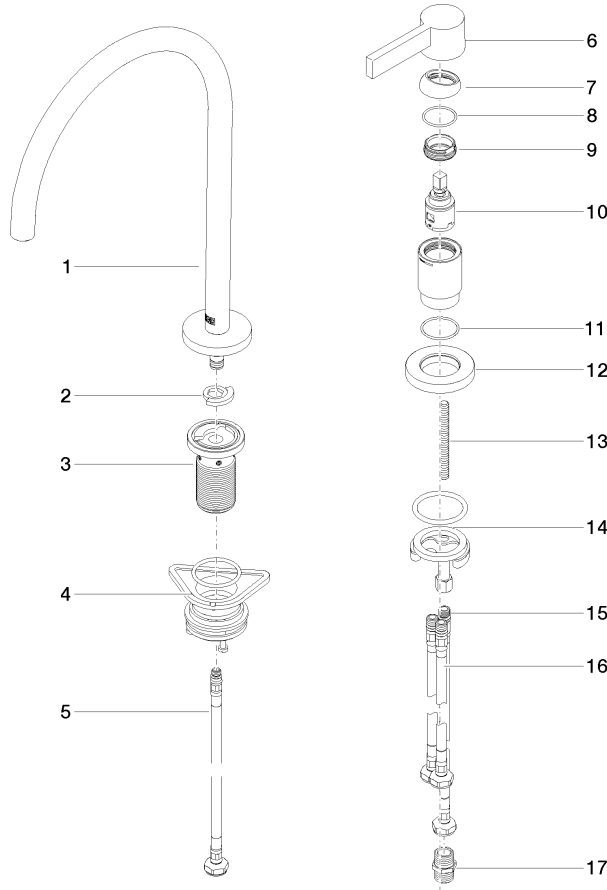

Liste des pièces de rechange

N°	Article Numéro	Désignation	Fréquence de montage	Délai de livraison
1	90 28 22 377 00-09	bec déverseur	1	-
La pièce de rechange ne peut plus être commandée, veuillez commander l'article de remplacement				
2	12 820 970 90	Kit de limitation de pivotement -	1	2
3	90 30 01 299 00 90	Tige	1	2
4	04 23 10 044 08 90	set de fixation	1	2
5	04 30 04 100 00 90	flexible	1	2
6	90 20 87 003 00-09	poignée	1	-
La pièce de rechange ne peut plus être commandée, veuillez commander l'article de remplacement				
7	09 28 30 026-09	hotte	1	60
8	09 14 10 091 90	joint	1	2
9	09 24 04 266 90	écrou	1	2
10	90 15 05 042 00 90	cartouche	1	2
11	09 14 10 110 90	joint	1	2
12	09 27 97 040-09	rosace	1	60
13	09 31 11 011 90	tige	1	2
14	04 30 11 085 97 90	set de fixation	1	2
15	04 30 04 104 00 90	flexible	1	2
16	04 30 04 105 00 90	flexible	2	2
17	90 24 03 250 00 90	raccord à vis	1	2