

33 502 660



- saillie 135 mm
- bec déverseur fixe
- jet circulaire enrichi en air
- hauteur de robinetterie 158 mm
- hauteur jusqu'au mousseur 77 mm
- diamètre de percement 35 mm
- 2x flexible de pression M 8 x 1 vissé, étanchéité contrôlée
- débit maxi. 5,7 l/min
- sans plomb
- Ce produit contribue au respect des exigences des systèmes d'évaluation des bâtiments écologiques, par exemple LEED®, BREEAM®, DGNB

Convient uniquement à un lavabo avec trop-plein.

	Noir mat	33 502 660-33
	Chrome	33 502 660-00
	Platine brossé	33 502 660-06
	Dark Chrome	33 502 660-19
	Or clair	33 502 660-26
	Or clair brossé	33 502 660-27
	Bronze brossé	33 502 660-42
	Champagne brossé (Or 22cts)	33 502 660-46
	Champagne (Or 22cts)	33 502 660-47
	Chrome brossé	33 502 660-93
	Dark Platinum brossé	33 502 660-99

33 502 660
mm [inches]



Diagramme de débit



Certificats

LGA_29690.

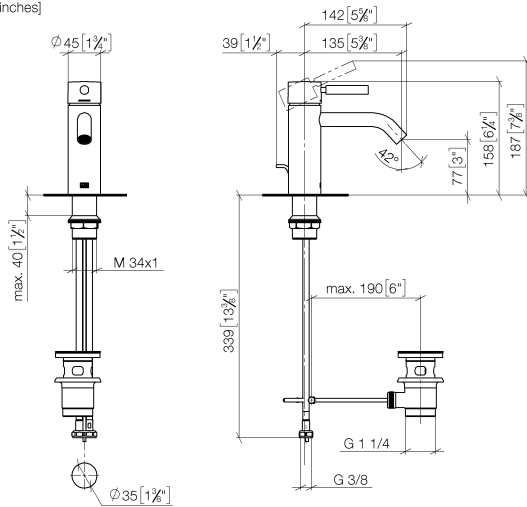
DVGW_DW-
6506DN0128.

WRAS_2003058.

33 502 660

Les pièces pour les autres finitions peuvent être trouvées ici : [Chrome](#)

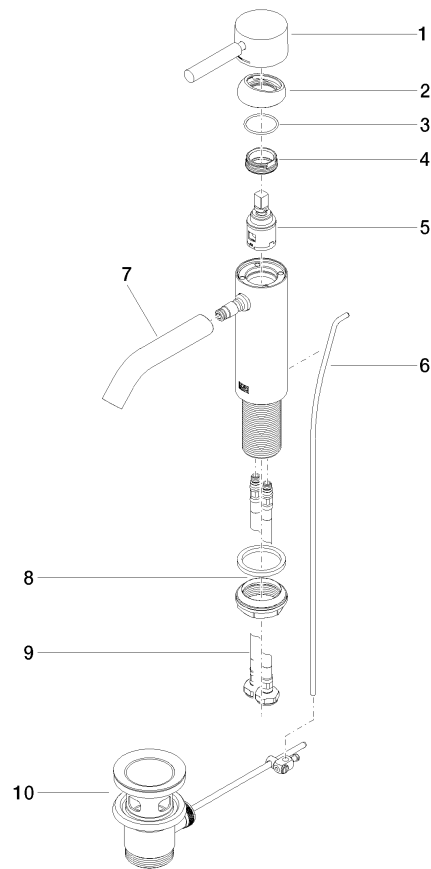

Liste des pièces de rechange

N°	Article Numéro	Désignation	Fréquence de montage	Délai de livraison
1	90 20 66 002 00-33	poignée	1	30
2	09 28 30 041-33	hotte	1	30
3	09 14 10 091 90	joint	1	2
4	09 24 04 266 90	écrou	1	2
5	90 15 05 042 00 90	cartouche	1	2
6	09 31 09 110-33	tige	1	30
7	90 11 06 207 00-33	bec déverseur	1	30
8	04 23 10 044 07 90	set de fixation	1	2
9	04 30 04 100 00 90	flexible	2	2
10	90 11 01 001 00-33	garniture d'écoulement	1	30